

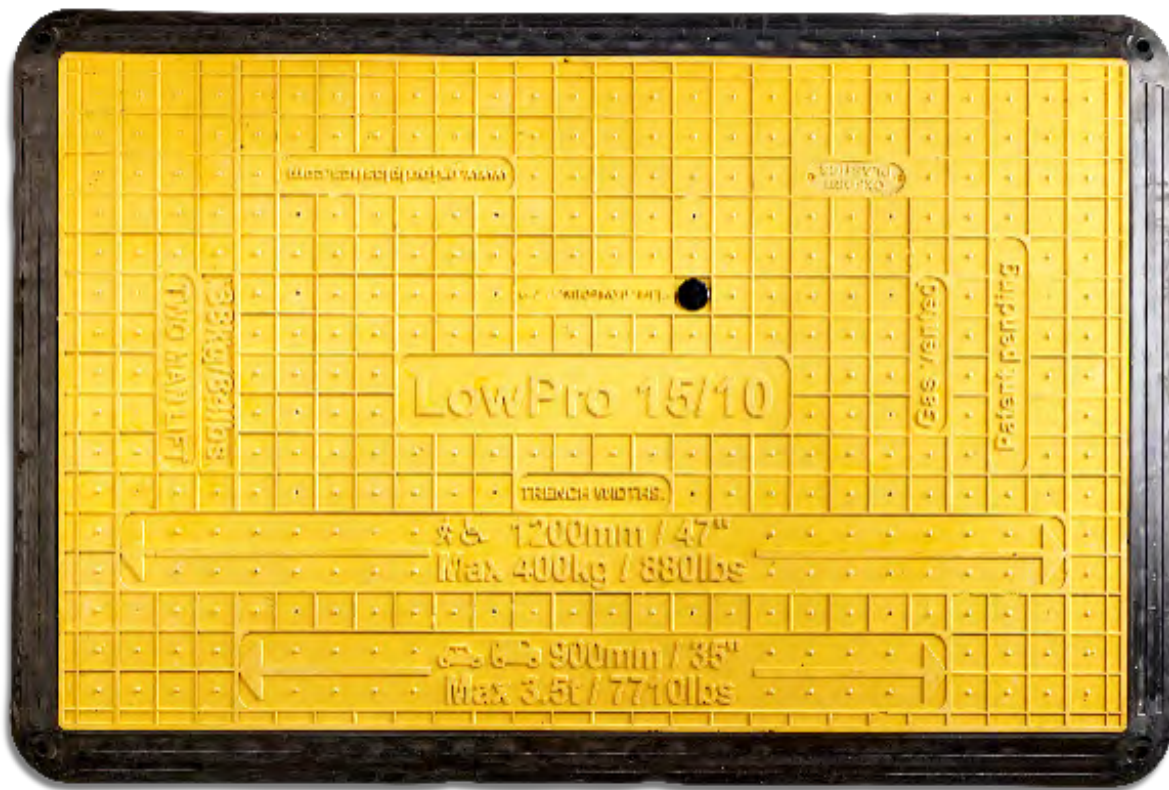

LOWPRO 15/10 TRENCH COVER





CONTENTS

PAGE

3	System Overview
4	Branding and Customisation
5	Features
6	Dimensions and weights
7	Material composition, product life and tracing
8	Load deflection data
9	Pedestrian usage only
10	Slip resistance
11	Inspection and maintenance
12	Installation and safe handling
13	Overlap and soil conditions
14	Infills and Linking Plates
15	Infills Installation
16	Ramps
17	Ramp Dimensions, weights and materials
18	Ramp Installation
19	Stillage
20	History of use
21	Composite Road Plate and Trench Cover Sales
22	Contact information
23	Appendix A - USA Engineering approval tabulated data





SYSTEM OVERVIEW

The LowPro 15/10 Trench Cover is a complete solution in 4 parts: LowPro, metal stillage, accessibility ramps & infill strips.

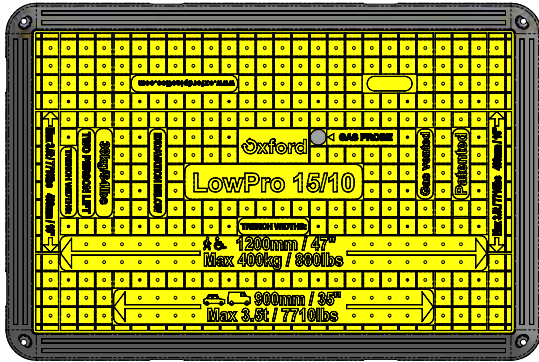

LowPro 15/10 Trench Cover

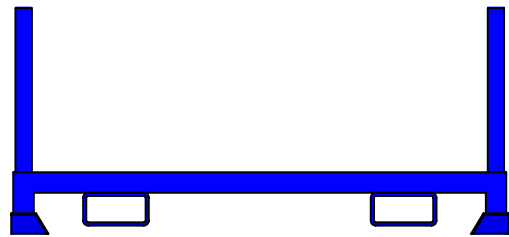

Metal Stillage

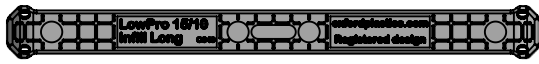

Long Infill



Short Infill

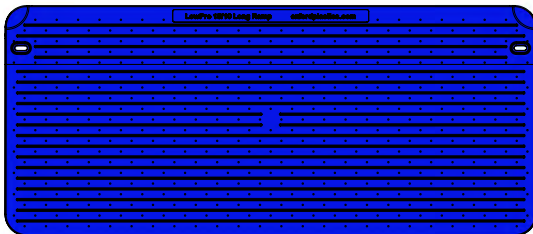

Long Ramp

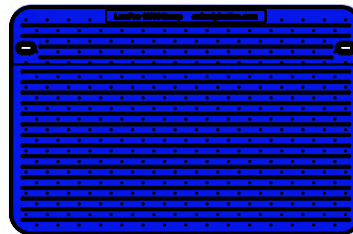

Short Ramp

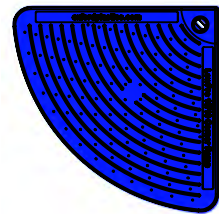

Corner Ramp

The market-leader in composite trench cover technology

The LowPro 15/10 Driveway Board is Oxford Plastics' composite trench cover, suitable for 3.5T vehicles across a 900mm trench. LowPro edges grip the asphalt to create a stable platform for vehicles and pedestrians.

Store & transport the LowPro 15/10 System

The LowPro Stillage holds 10 LowPro 15/10 Trench Covers. Made of durable galvanised steel, and fitted with forklift pockets to make transport quick and easy.

Ramps & Infill strips create an easy-access platform

Infill strips are installed between LowPro Trench Covers to connect the boards and prevent drift. The DDA & ADA compliant access ramps have a smooth 1:12 gradient, for a smooth slope for pedestrians and vehicles.





BRANDING AND CUSTOMISATION

	Standard Colour	Non-standard Colours Available	Embossing
LowPro 15/10 Trench Cover	Yellow	Orange, Red, Blue, Purple & Green	MOQ 60 off
LowPro Infills Long & Short	Black	N/A	N/A
LowPro Ramps Long, Short & Corner	Blue	N/A	N/A
LowPro Stillage	Blue	N/A	N/A

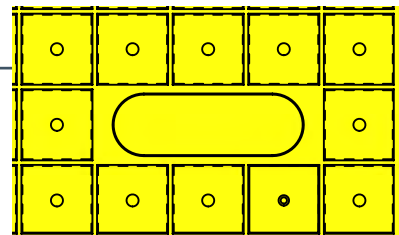
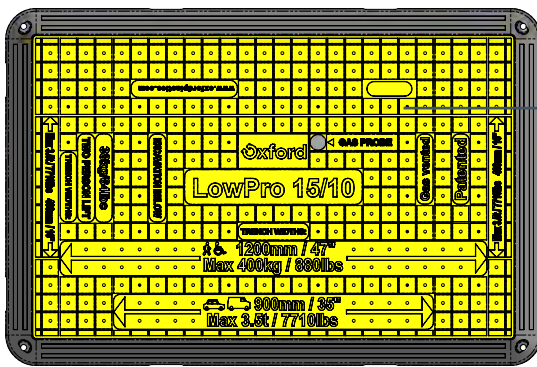

LowPro 15/10 Trench Cover Custom Embossing Area

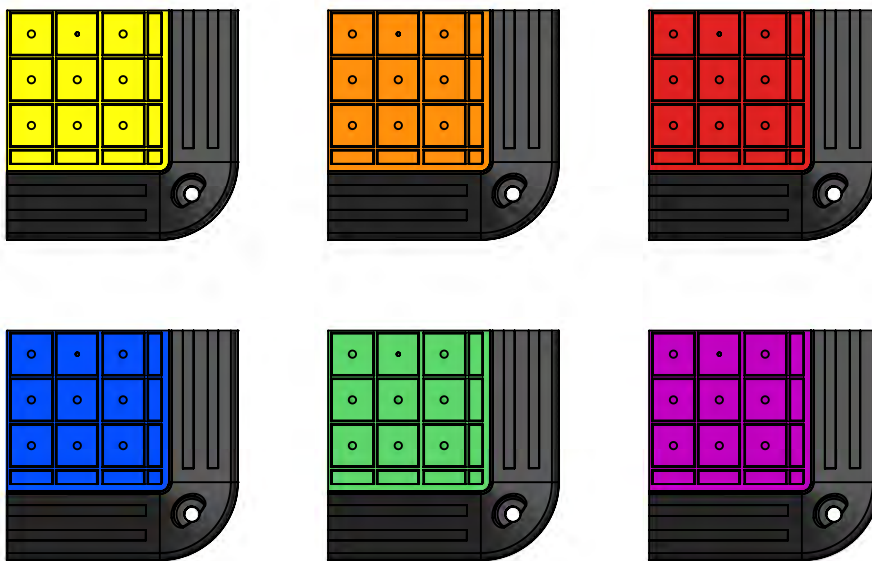

LowPro 15/10 Trench Cover Colour Options





FEATURES

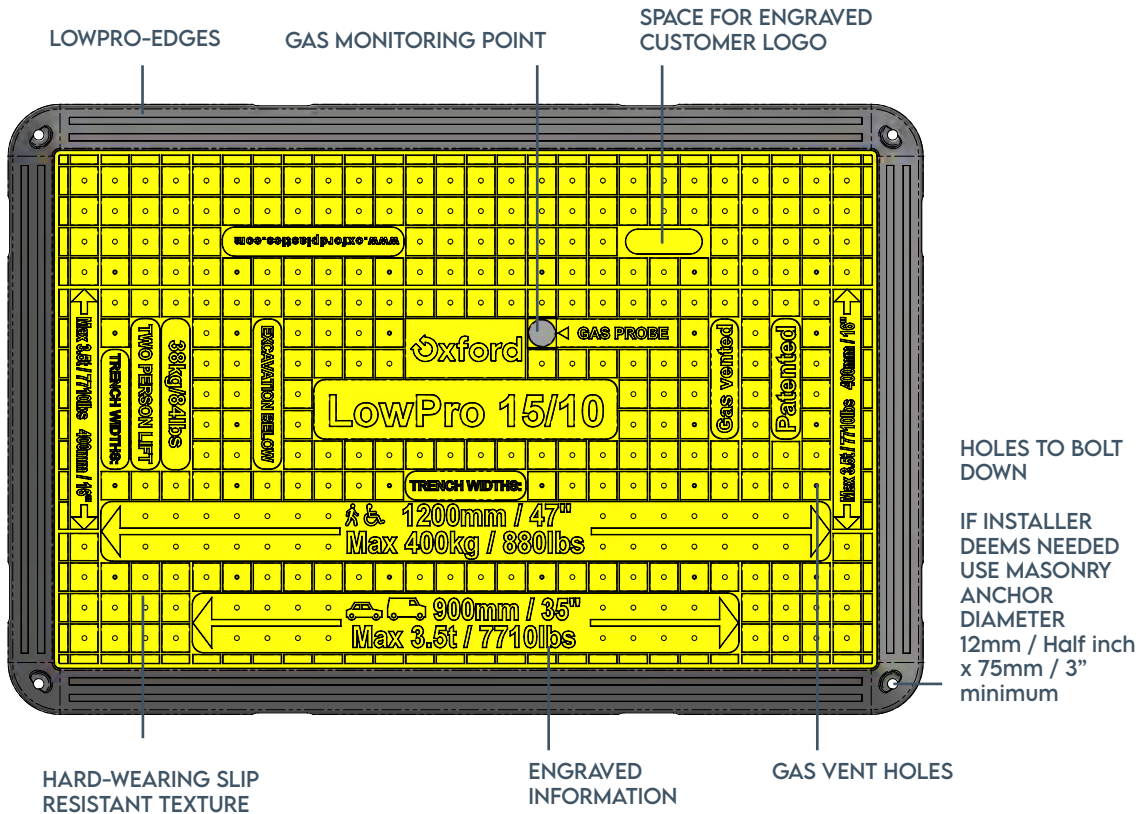

ROBUST

Advanced composite technology construction, robust and durable.

Integral slip resistant texture.

LowPro-edge prevents damage to road, reduces noise, and stops board sliding .

Proven to work in temperatures +50c to -30c.

Non-metal construction reduces theft.

SAFE & EASY TO USE

Can be manually handled without the need for heavy lifting equipment.

Quick to install.

Gas Monitoring point allows gas measurements to be taken without removing the trench cover.

Gas vent holes allow any gas build up to escape.

Can be bolted down.

EXTRAS

Can be customised with customer logos.

Infill pieces connect covers together to create a flat anti-trip platform.

Linking plates can be supplied to link units for added security.

Ramp sections can be supplied to create a gentle slope for wheelchair users & cyclists.





DIMENSIONS AND WEIGHTS

LOWPRO 15/10 TRENCH COVER 38Kg / 84lbs

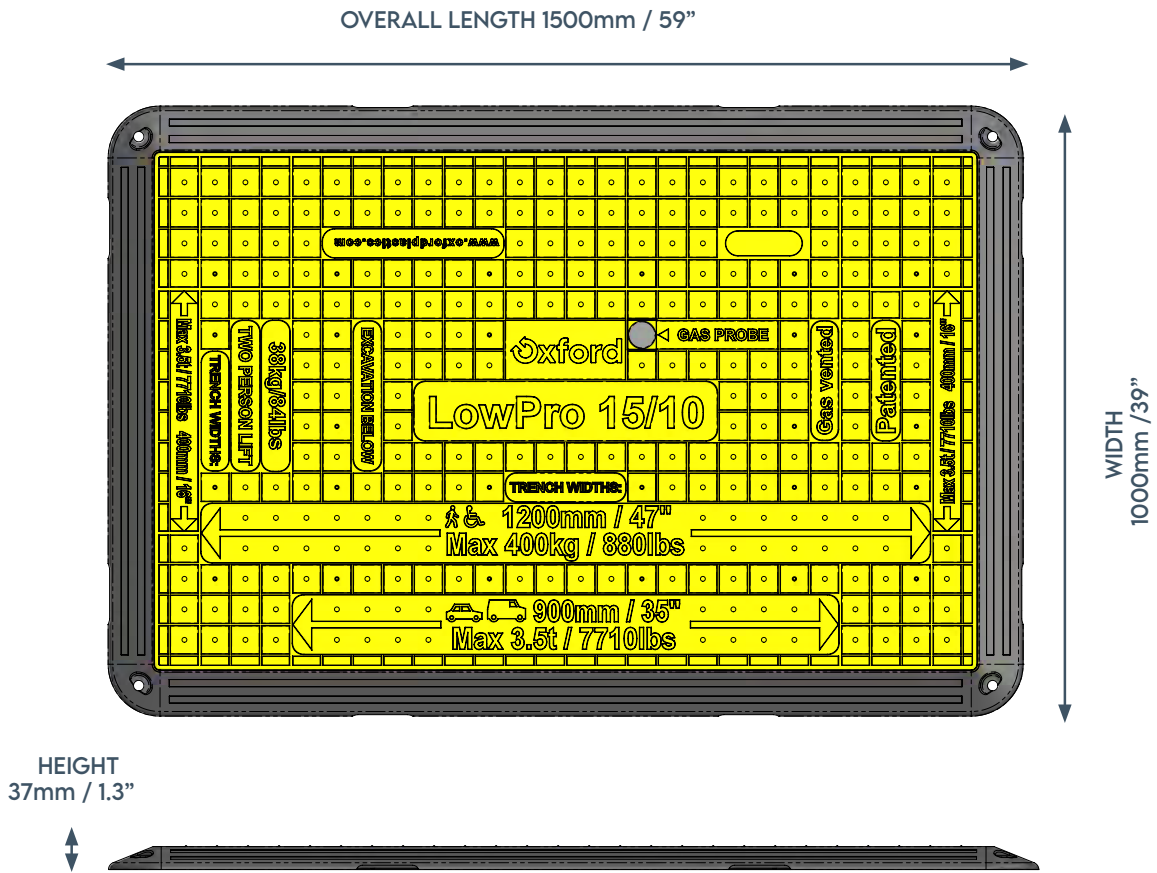

Part Name

LowPro 15/10 Driveway Board

Product Code

O815



MATERIAL COMPOSITION AND PRODUCT LIFE

All elements use materials that if maintained correctly will not structurally degrade in UV light, in the presence of water or salts, and are stable in temperatures from +50c / +120f to -30c / -20f.

Batches are regularly load tested in the Oxford Plastics test facility as part of the quality control process.

TRACING

Products have a waterproof label with a unique bar code and ID number, enabling tracing to the batch and date of manufacture.

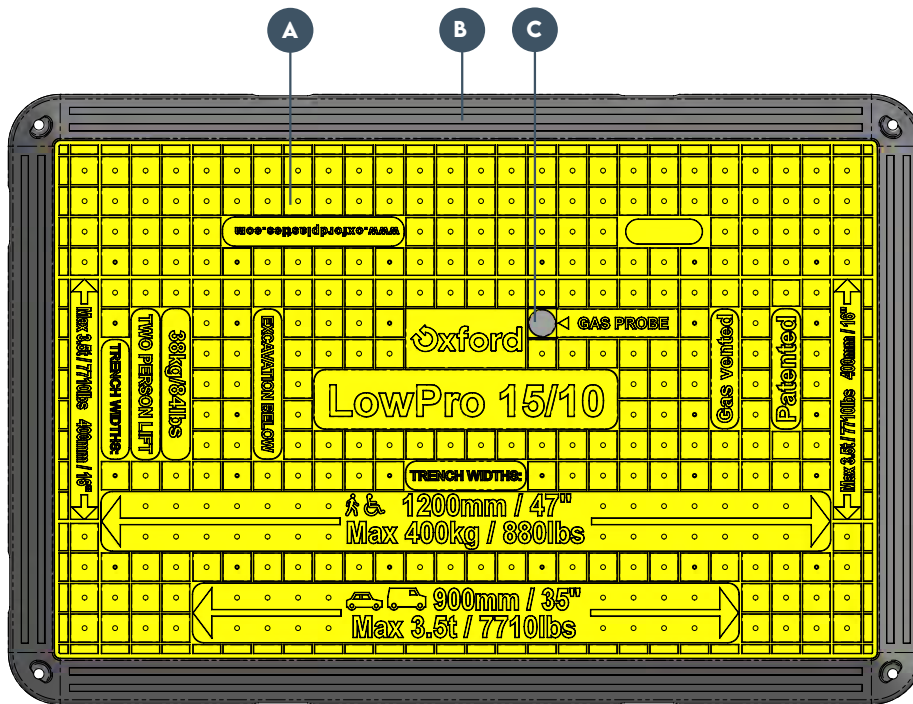

	Part Name	Material
A	Main Body	Glass fibre reinforced polyester resin sheet moulding compound + Mild Steel encapsulated rebar grid
B	LowPro-Edge	PVC
C	Gas Monitoring Bung	HDPE





LOAD DEFLECTION DATA

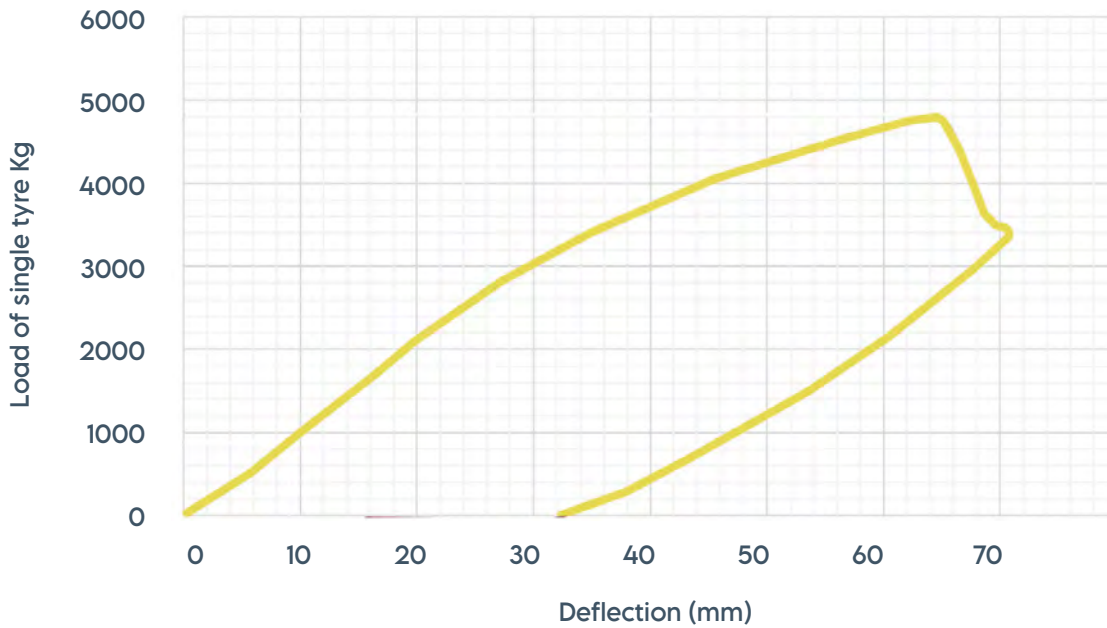

Deflection at 875Kg / 1930lb

9.0mm / 0.35"

Ultimate load at failure

4,800Kg / 10,582lb

Destructive testing has been carried out on the product to simulate deflection under the working load, and ultimate failure.

The testing is carried out by trained staff at Oxford Plastics' specialist testing facility.

Tab Data for the USA can be found in Appendix A.

PRODUCT RATING

The product is rated for use over spans of maximum 900mm / 36" by vehicles with a GVW of up to

3.5t / 7,700lb

TEST SPECIFICATION

Span
900mm / 36"

Load Footprint
250mm / 9.8" diameter pad with rubber base to simulate single tyre.

Load Location
Centre of product.





PEDESTRIAN ONLY USAGE

For scenarios where the product will only experience loads of up to 400Kg then the maximum span can be increased to 1200mm.

The installer should carry out a risk assessment to ensure the edge of the trench is stable enough. For example, for excavations in concrete, asphalt or compacted soil.

The product must be positioned centrally on the trench.

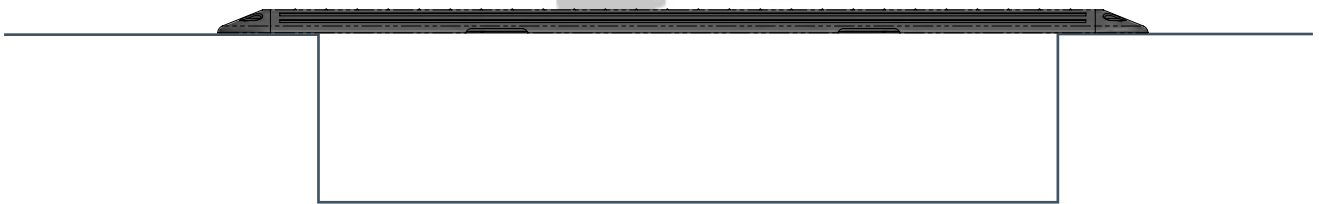

PEDESTRIAN ONLY USE	Metric	Imperial
Max Span	1200mm	47"
Max Load	400Kg	880lb





SLIP RESISTANCE

Slip Resistance testing has been carried out by an independent test house, in line with the requirements of UK HSE 2012 document 'Testing the slip resistance of flooring'.

Testing was carried out in 3 directions in wet and dry conditions, using a calibrated Munro slip tester using Slider 55 and Slider 96.



CLASSIFICATIONS

High Slip Potential
0-24

Medium Slip Potential
25-35

Low Slip Potential
36+

SLIDER 96 TEST RESULTS - DRY

	Median Result	Classification
Parallel to traffic	68	LOW SLIP POTENTIAL
45 degrees to traffic	62	LOW SLIP POTENTIAL
Perpendicular to traffic	55	LOW SLIP POTENTIAL

SLIDER 96 TEST RESULTS - WET

Parallel to traffic	45	LOW SLIP POTENTIAL
45 degrees to traffic	44	LOW SLIP POTENTIAL
Perpendicular to traffic	40	LOW SLIP POTENTIAL

SLIDER 55 TEST RESULTS - DRY

Parallel to traffic	67	LOW SLIP POTENTIAL
45 degrees to traffic	69	LOW SLIP POTENTIAL
Perpendicular to traffic	66	LOW SLIP POTENTIAL

SLIDER 55 TEST RESULTS - WET

Parallel to traffic	46	LOW SLIP POTENTIAL
45 degrees to traffic	39	LOW SLIP POTENTIAL
Perpendicular to traffic	40	LOW SLIP POTENTIAL





INSPECTION AND MAINTENANCE

Care for the product by following the below guidance:

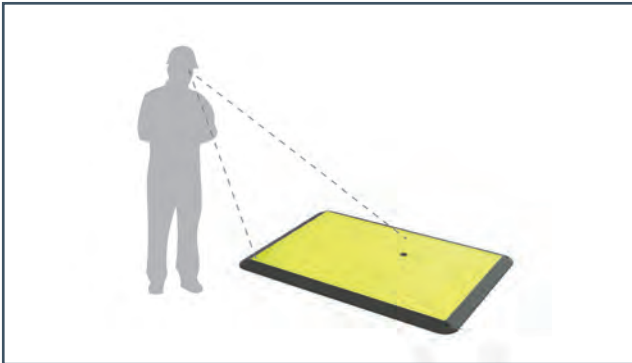

Inspect each product for signs of damage, between every installation.



Clean product between every installation to remove debris, and to maintain slip resistance properties.



Do not drop the product.
Do not lift or move with machinery.

SIGNS OF DAMAGE

Cracks in the yellow section indicate it has been damaged through improper use.

The product should lay flat on the ground. A visibly bent product also indicates it has been damaged through improper use.

These products need to be disposed of.





INSTALLATION AND SAFE HANDLING

Follow the process below for safe and effective installations.

Risk assessments should be carried out to ensure the usage is suitable for the scenario.

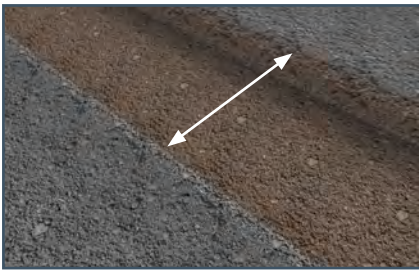

Confirm trench widths suitable:
PEDESTRIAN ONLY 1200mm.
VEHICLES 900mm.

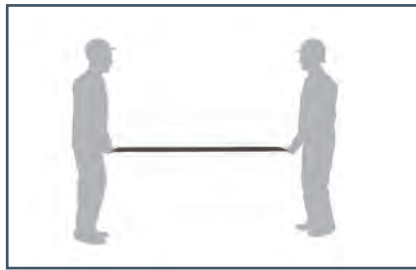

Two person lift at all times.

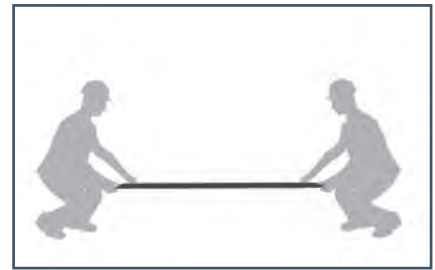

Bend at the knees in line with best practise.

Assess Trench stability prior to install.

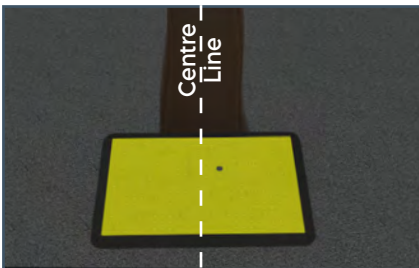

Position product centrally over trench..

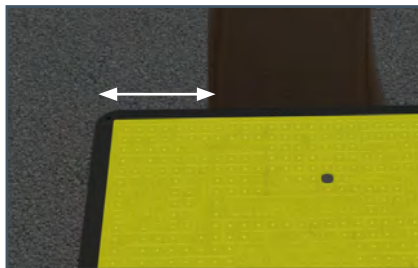

Check there is a minimum overlap
PEDESTRIAN ONLY 150mm
VEHICLES 300mm
Do this for every piece.



Repeat until the entire trench is covered.





OVERLAP AND SOIL CONDITIONS

Ensure the product is centred on the trench, with a minimum overlap as shown below.

VEHICLES

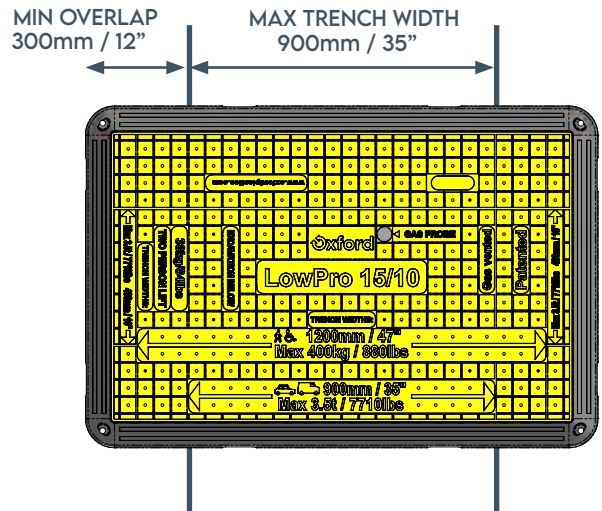
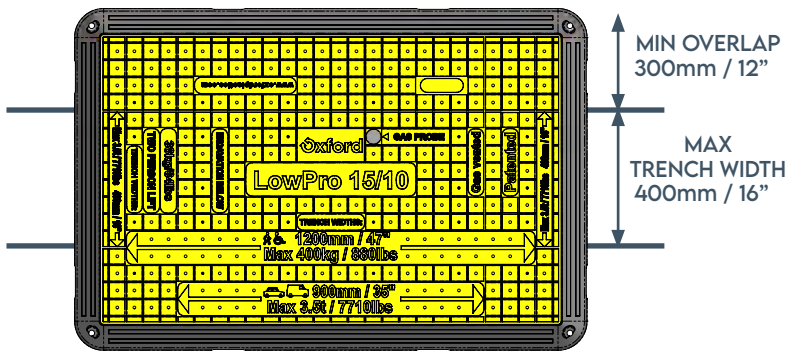

PEDESTRIANS ONLY

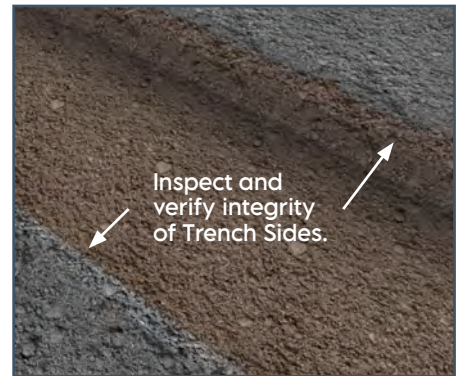
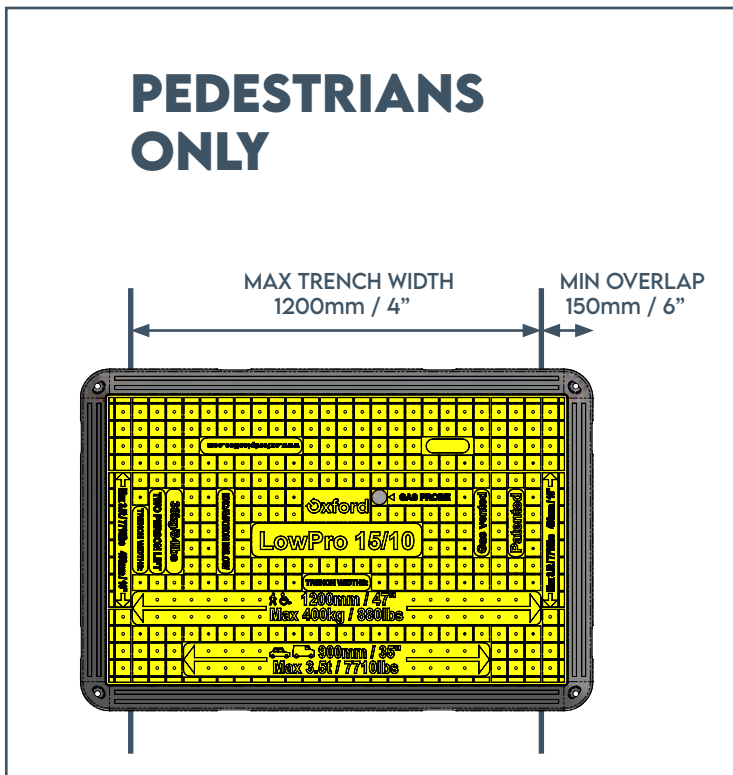

SOIL CONDITIONS

The soil or other substrates at the trench edges must be capable of supporting the maximum weight of vehicle for the particular install.

Risk Assessments must be carried out prior to installation.





INFILLS & LINKING PLATES

Infills remove the recess between boards when 2 or more are used.

The linking plates connect the Infills, and also link each Board together for added safety.

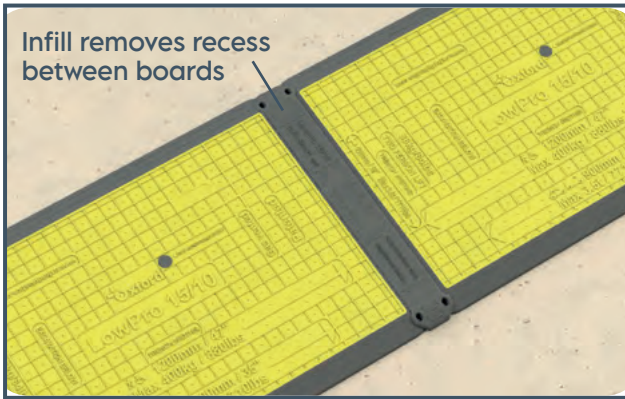

The short Infill is suitable for narrow trenches, where LowPros are installed landscape.

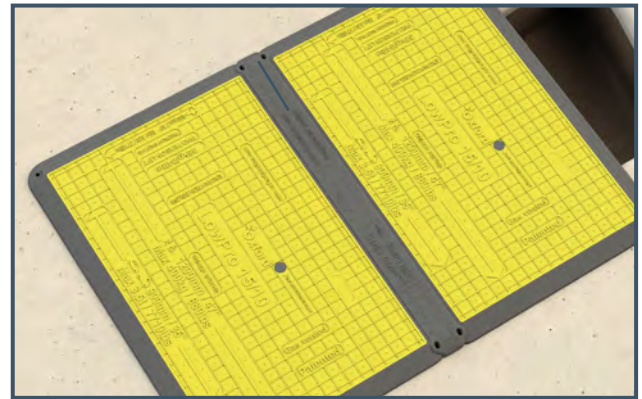

The long Infill is suitable for wider trenches, where LowPros are installed portrait.

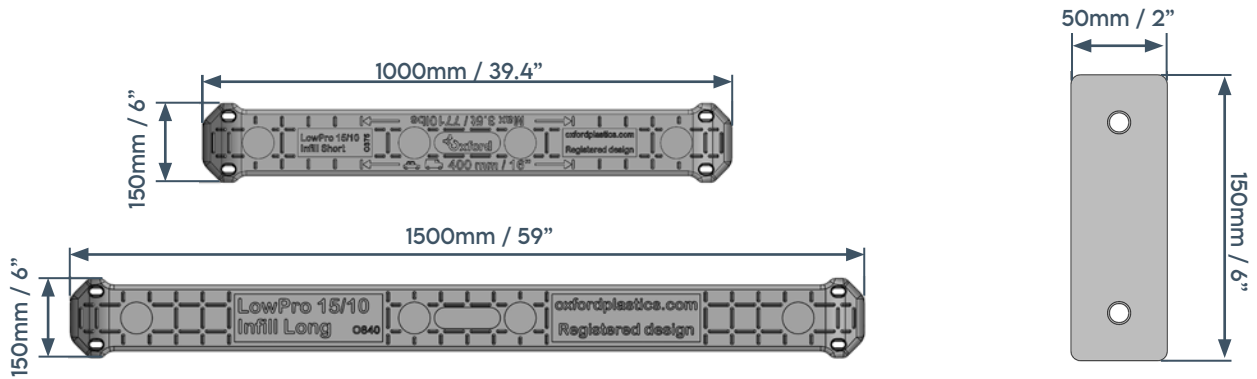

Part Name	Product Code	Material
Short Infill	O375	PVC
Long Infill	O840	PVC
Connector Plate	Supplied with the Infill	Zinc Plated Steel
Connector Plate Bolts	Supplied with the Infill	M10 x 20 hex head flanged bolt with zinc yellow coating



INFILL INSTALLATION

Follow the process below for safe and effective installations.

Risk assessments should be carried out to ensure the usage is suitable for the scenario.

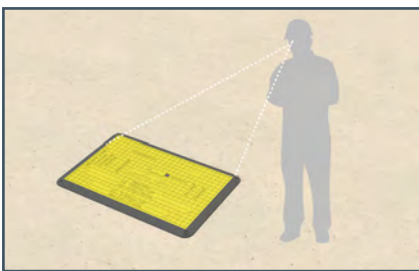

1. Assess the surrounding surface where the LowPro edges will be resting.



2. Unscrew the plate and bolts at each end of the Infill.

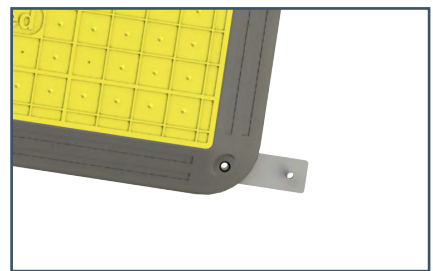

3. Insert the plate underneath the LowPro through the bolt hole.

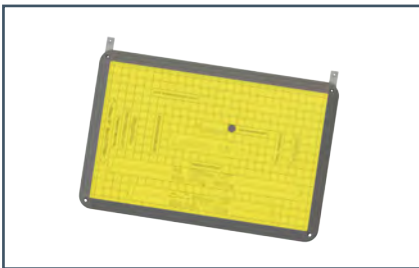

4. Insert the 2nd plate in the bolt hole on the long or short side.

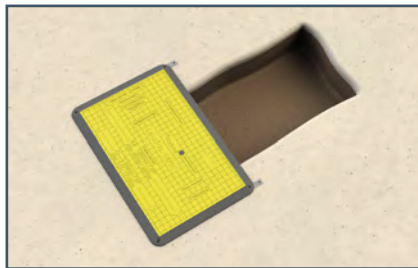

5. Place the LowPro with the plates centred over the width of the trench.



6. Place the next LowPro in line with first over the Infill plate.

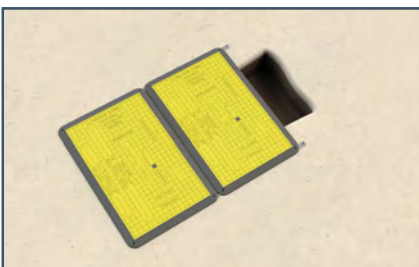

7. Ensure the LowPro is sitting on the plate at both ends.

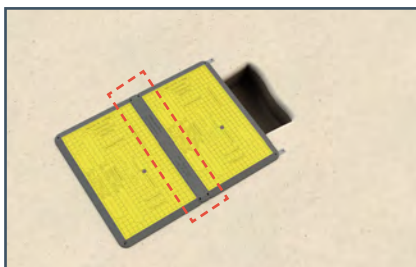

8. Place the Infill between the LowPros & secure with 2 bolts at either end.

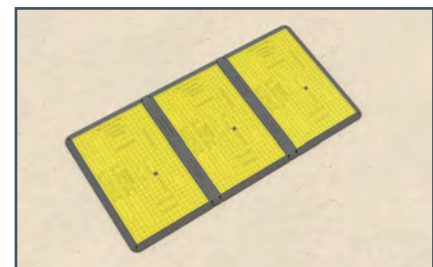

9. Continue placing LowPros over the trench & attaching Infills until the trench is fully covered.





RAMPS

Ramps provide a gentle 1:12 slope for wheelchair users.

They can be used in conjunction with the Infills and Linking plates.

ADA COMPLIANCE

The ramp products have been developed in reference to the 2010 ADA Standards for Accessible Design.

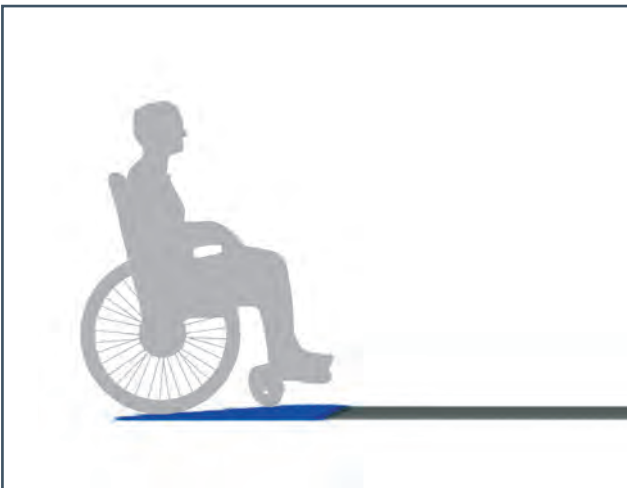

Ramps provide a gentle 1:12 slope.

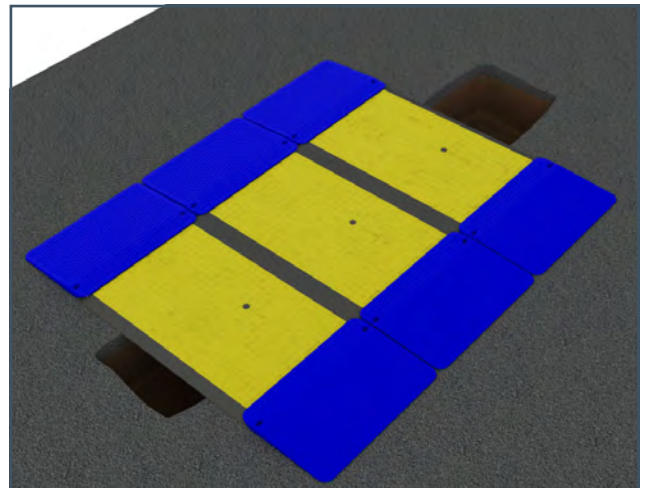

Short Ramps can be used in this scenario, attached to the short sides of the LowPro.

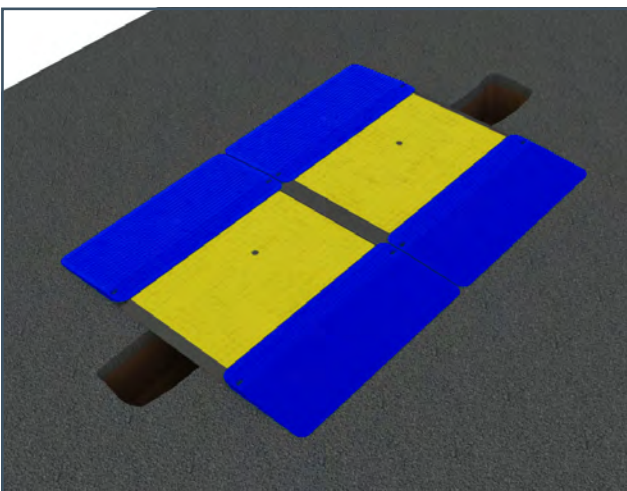

Long Ramps can be used in this scenario, attached to the long sides of the LowPro.

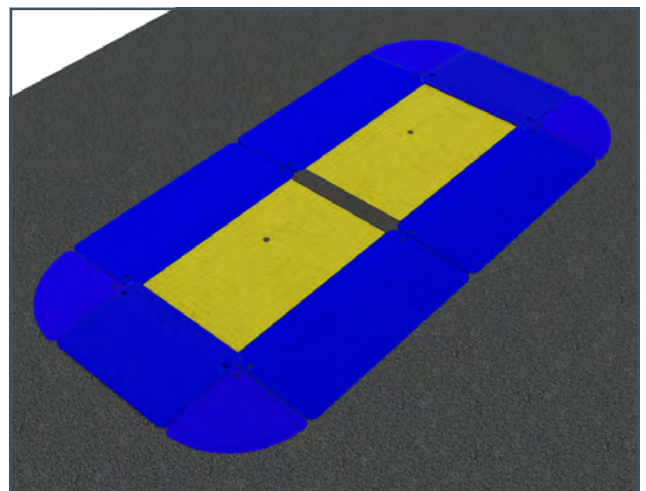

Short Ramps, Long Ramps, and Corner Ramps can be arranged to create a gentle slope on all sides.





RAMP DIMENSIONS WEIGHTS & MATERIALS

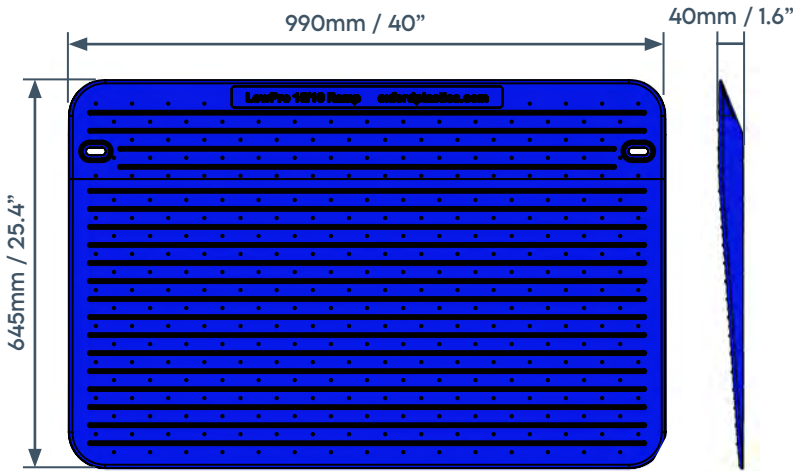

Short Ramp - 8.75kg / 19.3lb

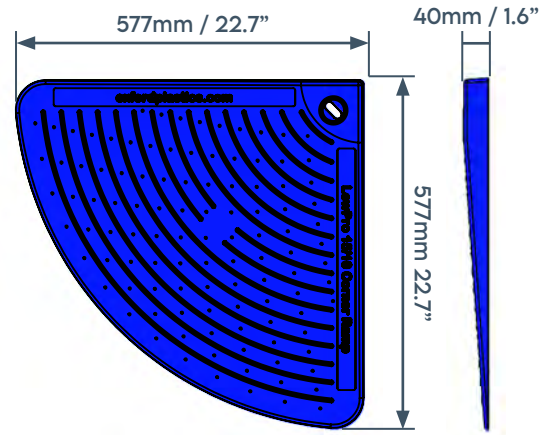

Corner Ramp - 2.45kg / 5.4lb

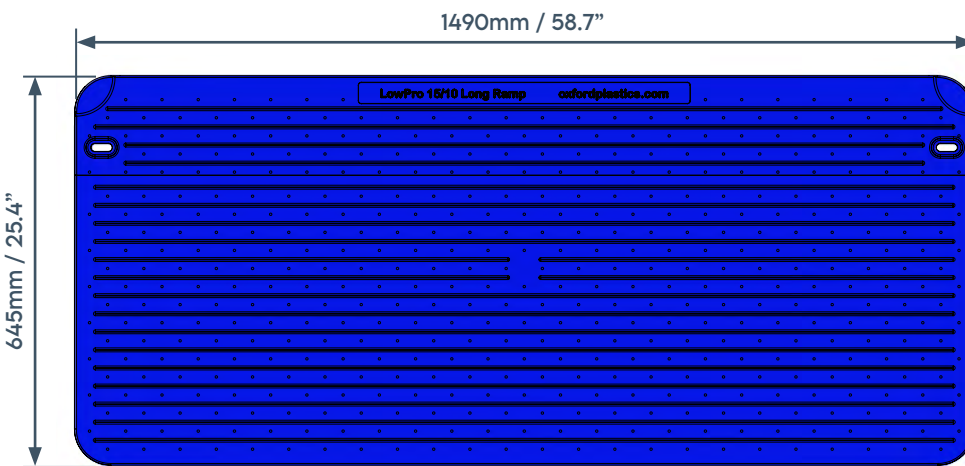

Long Ramp - 9kg / 20lb

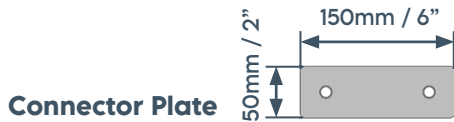

Connector Plate

4-way

Connector Plate

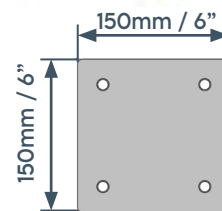

Part Name	Product Code	Material
Short Ramp	O798	Thermoplastic Elastomer
Long Ramp	O774	Thermoplastic Elastomer
Corner Ramp	O775	Thermoplastic Elastomer
Connector Plate	Supplied with ramps	Zinc Plated Steel
4-way Connector Plate	Supplied with ramps	Zinc Plated Steel
Connector Plate Bolts	Supplied with ramps	M10 x 20 hex head flanged bolt with zinc yellow coating



RAMP INSTALLATION

Follow the process below for safe and effective installations.

Risk assessments should be carried out to ensure the usage is suitable for the scenario.

The Ramps should not be placed over the trench.

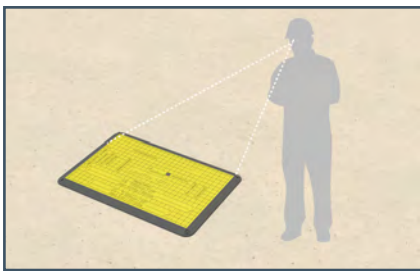

1. Assess the surrounding surface where the LowPro edges will be resting.



2. Unscrew the plate and bolts at each end of the Infill.

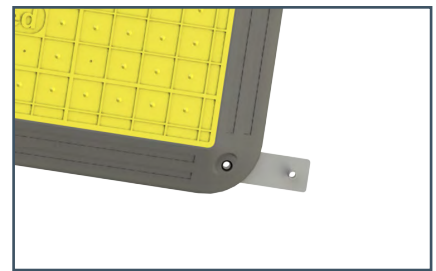

3. Insert the plates underneath the LowPro through the bolt hole.

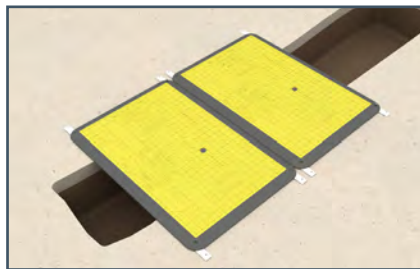

4. Place the LowPros with the plates centred over the width of the trench.

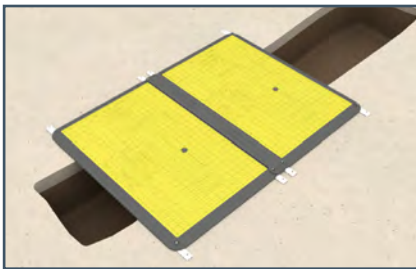

5. Place the Infill between the LowPros, fix Infills with bolts.

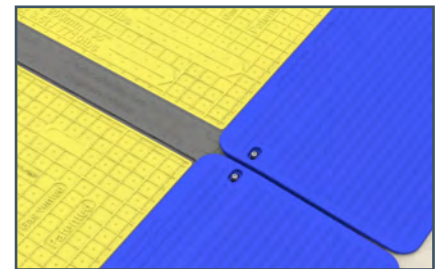

6. Place the Ramps onto the studs on the Plates, and fix Ramps with Bolts.

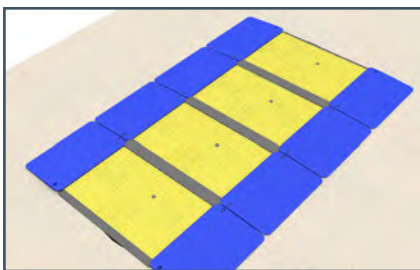

7. Continue placing LowPros over the trench & attaching Infills until the trench is fully covered.

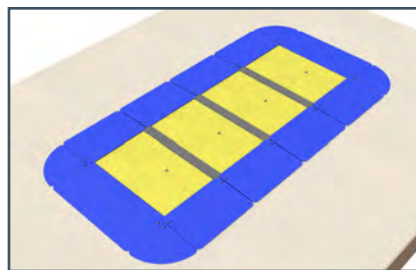

8. For Ramps on all sides use the 4-Way connector at the corners.

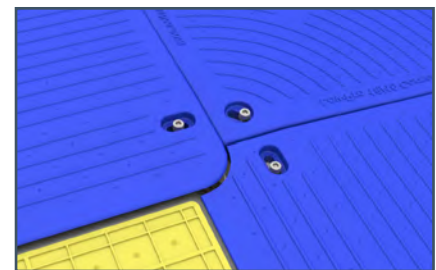

9. For Ramps on all sides the Long Ramp corner must be cut with a knife to fit up against the Short Ramp. A Mark on the Ramp shows where to cut.





STILLAGE

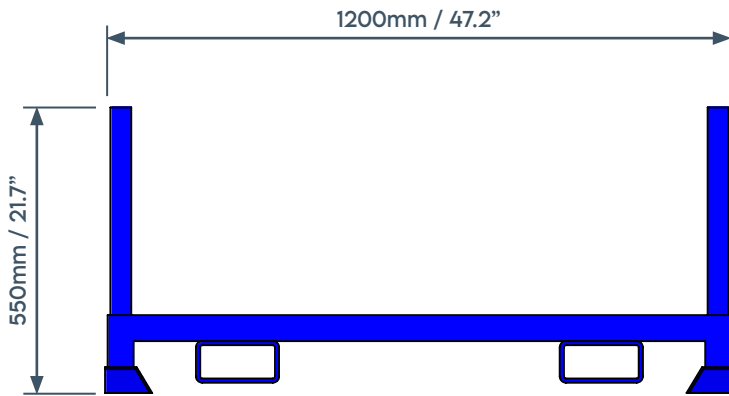

FEATURES AND BENEFITS

- Stack ten LowPro 15/10 on a stillage
- Stack stillages on top of one another
- Comes with forklift pockets
- Durable steel material
- Galvanised for protection from rust

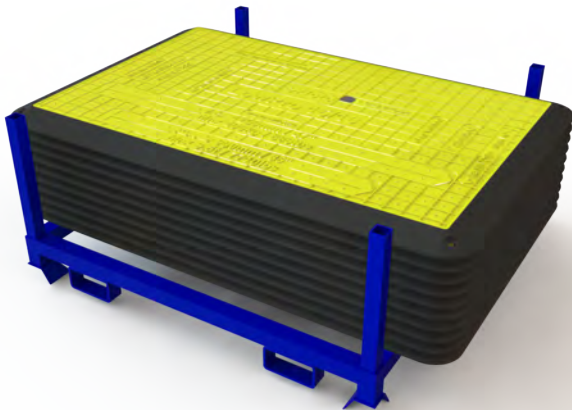

Stillage shown with ten LowPro 15/10

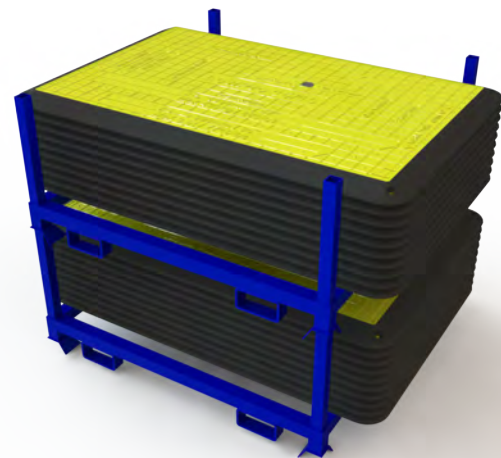

Two laden stillages shown stacked

LOWPRO STILLAGE

Product Code	5513
Tool Code	0746
Weight	42kg
Colour	Blue
Quantity / Pallet	1





HISTORY OF USE

Our composite Road Plates and Trench Covers have been used extensively:



METROPOLITAN USERS

- London
- New York
- Paris
- Munich
- Seoul
- Madrid
- San Francisco
- Tokyo
- Sydney



UTILITY USERS

- Gas
- Water
- Telecoms
- Electricity





COMPOSITE ROAD PLATE & TRENCH COVER SALES

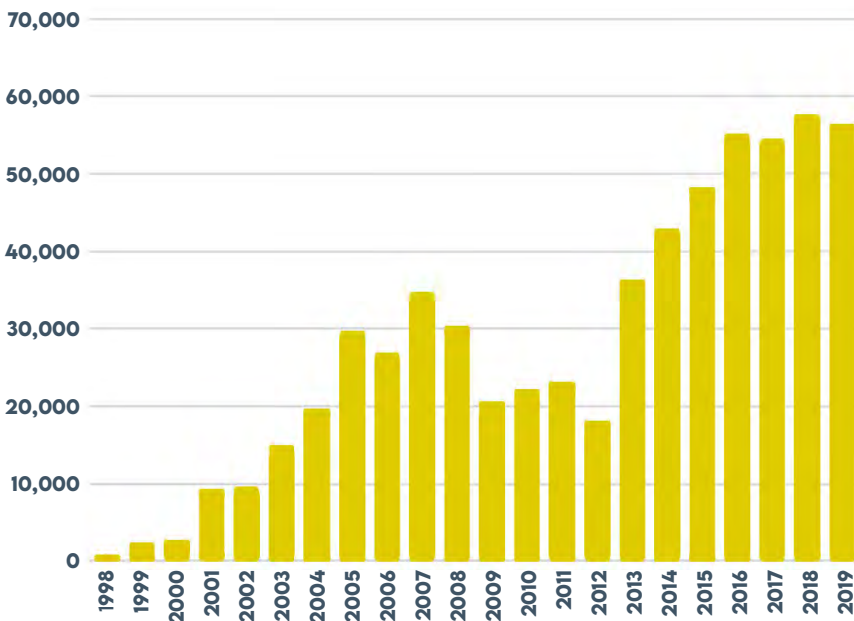

UNIT SALES

First concepts and products launched

1998

Worldwide sales since launch

+£32.8m

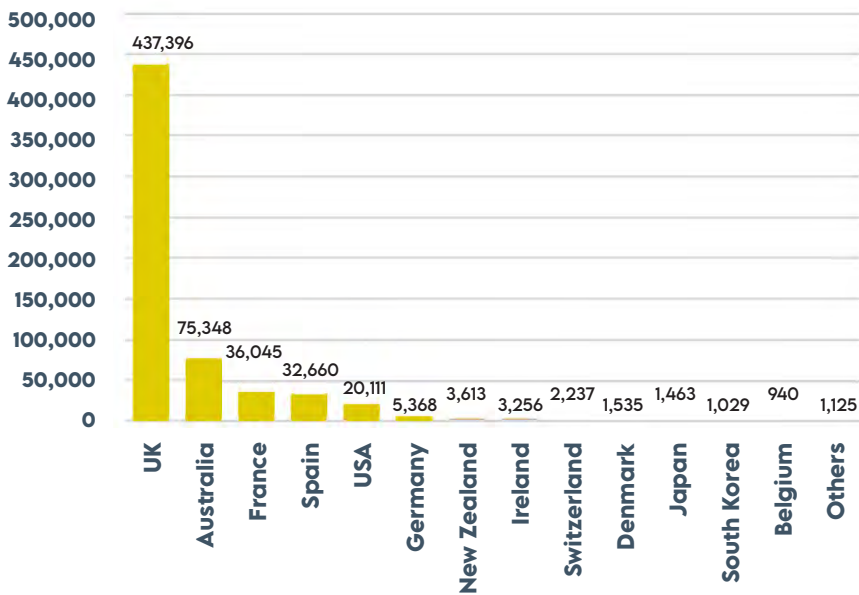

UNIT SALES BY COUNTRY

Countries using composite Road Plates and Trench Covers

42

Installations globally

+600k





CONTACT INFORMATION



telecroatian network
www.telecron.net

UK & R.O.W

Oxford Plastic Systems Ltd
Unit T2, Enstone Business Park
Enstone,
Chipping Norton
Oxfordshire
OX7 4NP
United Kingdom

sales@oxfordplastics.com
Tel: +44(0)1608 678888

USA

Oxford Plastic Systems LLC
1011 Centre Rd,
Suite 312,
Wilmington
DE
19805
USA

info@oxfordplasticsusa.com
1-800-567-9182





APPENDIX A

USA Engineering approval tabulated data
See following pages





**J.M. TURNER
ENGINEERING, INC.**
Consulting Engineers

CIVIL ENGINEERING • STRUCTURAL ENGINEERING
CONSTRUCTION ENGINEERING

1325 College Avenue * Santa Rosa, CA 95404 * Phone (707) 528-4503 * Fax (707) 528-4505

E-MAIL TRANSMITTAL COVER SHEET

TO:	<u>David Sardinha/Peter Creighton</u>	FROM:	<u>Hans Vermeulen</u>
COMPANY:	<u>Oxford Plastics</u>	DATE:	<u>5/13/2020</u>
PHONE:	<u>401-497-0821</u>	PAGES:	<u>13 including cover sheet</u>
E-MAIL:	<u>See Below</u>	RE:	<u>15/10 Manufacturers TD Sheet</u>

E-MAILED BY: HV TIME: 3:45 pm

MESSAGE:

David.sardinha@oxfordplasticsusa.com ; peter.creighton@oxfordplastics.com Job #17682-1

See attached revised tab data sheets.

Mailed copies are available upon request.

Thank you!



**J.M. TURNER
ENGINEERING, INC.**

Consulting Engineers

CIVIL ENGINEERING • STRUCTURAL ENGINEERING
CONSTRUCTION ENGINEERING

**15/10 LOW PRO OXFORD DRIVEWAY PLATE
TABULATED DATA**

**36" MAX. CLEAR SPAN TRENCH OPENING
(7710 LB TIRE LOAD)
OR 48" MAX. CLEAR SPAN TRENCH OPENING
(880 LBS PEDESTRIAN LOAD)**

**OXFORD PLASTIC SYSTEMS LLC
1011 Centre Rd. Suite 312
Wilmington, DE 19805**

Design of 15/10 Low Pro Oxford Driveway Plate is based on 880 Lbs. pedestrian load or 7710 Lbs. Traffic Load. The maximum allowable clear span = 48 inches (pedestrian) and 36 inches (traffic). Driveway Plate size is 3'-3" x 4'-11" (990 mm x 1500 mm)



DATE: 04/30/2020
REV: 05/13/2020
DESIGN BY: A.J.V.
SHEET NO: 1 of 9
JOB#: 17682-1



15/10 Driveway Plate deflection capacity based on Load Testing (deflection Criteria): Tire Load

Ultimate testing Load (Metric Tonnes): $P_{tonnes} := 3.5$

Ultimate Load (kips): $P_{ult} := P_{tonnes} \cdot 2.2$ $P_{ult} = 7.700$

Span Length (ft): $L_{ft} := 2.92$ (900mm)

Allowable Deflection = 5% of span (in): $Dfl_{allow} := 2.92 \cdot 0.05 \cdot 12$

$Dfl_{allow} = 1.75$ (45mm)

Maximum deflection at testing load (mm) $Mdf_{max} := 35$ mm

Maximum deflection at testing load (In) $Mdf_{l} := \frac{Mdf_{max}}{25.4}$ $Mdf_{l} = 1.38$

< 1.75 Inches Allowable ..
OK

Ok for 36" clear span

15/10 Driveway Plate deflection capacity based on Load Testing (deflection Criteria): Pedestrian Load

Ultimate testing Load (Kips): $P_{ult} := 0.880$

Span Length (ft): $L_{ft} := 3.92$ (1200mm)

Allowable Deflection = 5% of span (in): $Dfl_{allow} := L \cdot 0.05 \cdot 12$

$Dfl_{allow} = 2.35$ (60mm)

Maximum deflection at testing load (mm) $Mdf_{max} := 9.8$ mm

Maximum deflection at testing load (In) $Mdf_{l} := \frac{Mdf_{max}}{25.4}$ $Mdf_{l} = 0.39$

< 2.35 Inches Allowable ..
OK

Ok for 48" clear span

Product Load Test Report

Oxford Plastic Systems 15/10 LowPro

Test date: 11/7/2018

Summary

The Oxford Plastics 15/10 LowPro has been tested over a span of 900mm. It was tested in accordance with Highway Authorities & Utilities Committee (HAUC) advice note number 2018/01.

The performance required by the advice note is a maximum deflection of 5% of the span at a working load of 875kg and an ultimate load greater than 1750kg.

A single product was tested which **passed both requirements**. The **deflection at 875kg was 1% of span (9.0mm)** and the **ultimate load was 4800kg**.

Jedco Product Designers Ltd
Quadrant House 7-9 Heath Road Weybridge Surrey KT13 8SX
info@jedco.co.uk
01932 852497



Introduction

This document reports on the testing of the Oxford Plastics 15/10 LowPro.

Testing has been completed following the requirements specified in the Highway Authorities & Utilities Committee (HAUC) advice note 2018/01.

This advice note also specifies the following performance requirements in section A3.1.

When loaded at the centre, driveway boards should be capable of supporting a working load of 875kg with a deflection of no more than 5% of the maximum allowable span over the design life of the board. The ultimate failure load should not be less than 1750kg.

The 15/10 LowPro is specified for a maximum span of 900mm. Therefore the maximum deflection allowed under a load of 875kg is 45mm.

Product

Oxford Plastic Systems 15/10 LowPro (see Figure 1 below)

Length: 1494mm

Width: 995mm

Height: 43mm

Weight: 40.75kg

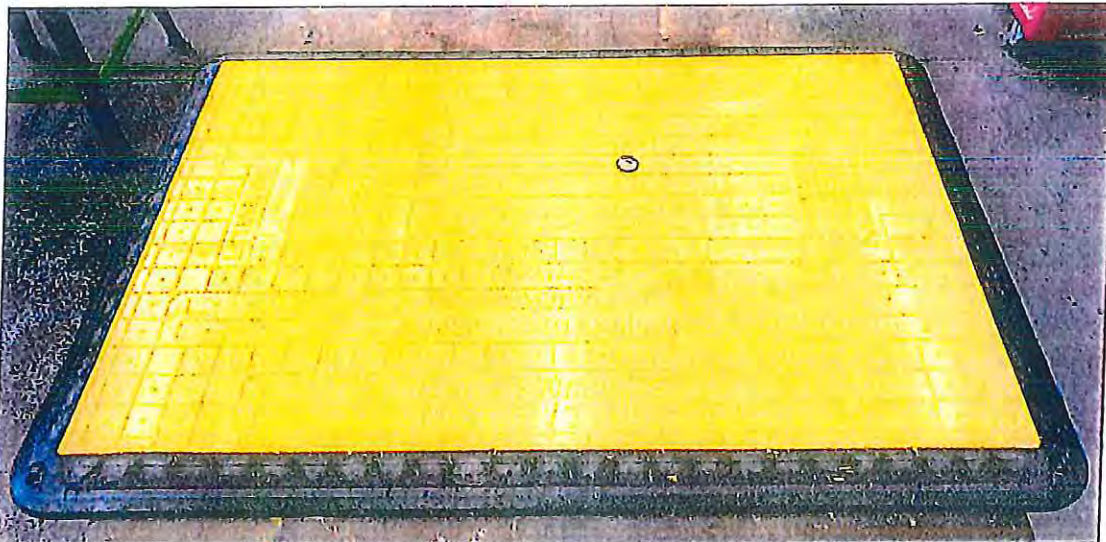

Figure 1: Oxford Plastic Systems 15/10 LowPro

Test Equipment

The testing equipment used is listed below:

Load Cell

PT Global Universal High Accuracy Load Cell

Displacement Sensor – reading from the centre of the underside of the product
PIL Ultrasonic distance sensor

Actuator

Power Team 229.5kN double acting hydraulic cylinder

Data logger

Pico Technology ADC-20

Test Setup

Section A2 of the HAUC advice note requires that product not be fixed and is loaded in the centre with a 250mm diameter load pad.

The supports are unspecified and have been selected to simulate trench sides. The test setup can be seen in the diagram below (Figure 2). The black in the diagram indicates the location of the load pad and the supports.

- Span: 900mm
Load pad: 250mm diameter steel plate, cushioned with 8mm PVC
Supports: Steel I-beams to simulate trench sides

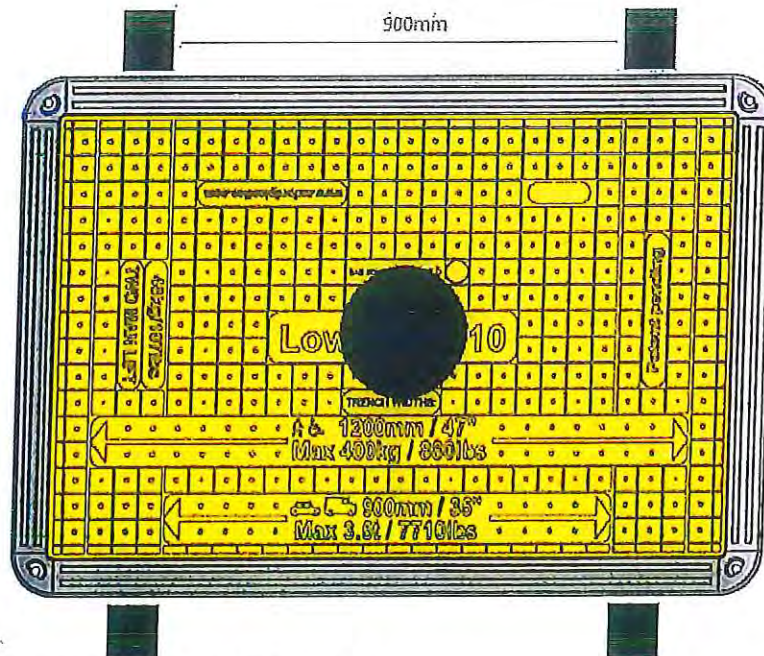

Figure 2: Test load footprint and location

Testing Process

The load was applied at a rate of approximately 100N/s. Loading was increased until the ultimate load was achieved which defined as when the force decreased over an extended period as deflection increased.

Figure 3 below shows the product at the beginning of the test. An accompanying video of the test is also available.

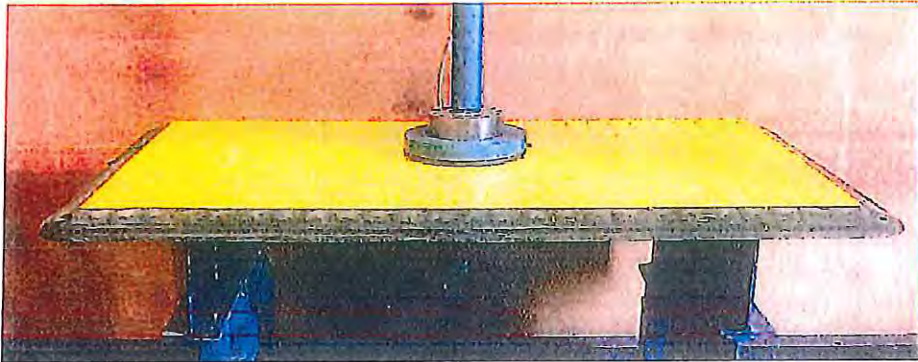

Figure 3: Screen shot just prior to testing

Results

Load and displacement were recorded and graphed. The results are displayed in Figure 4 below.

At a working load of 875kg a deflection of 9.0mm was recorded. This equates to 1% of the span. The ultimate failure load was recorded as 4800kg.

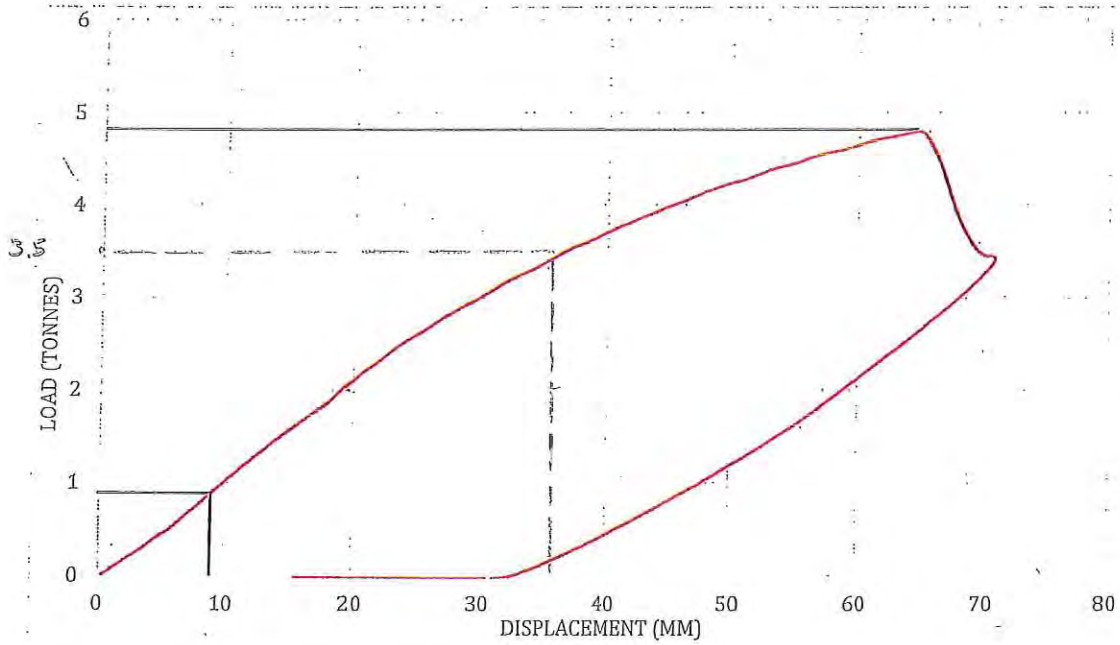

Figure 4: Test Results 15/10 LowPro Load vs. displacement

SHORT EDGE SPAN ADDED TO BOTH ENDS

"OXFORD" LOGO ADDED

TEXT UPDATED TO "TWO PERSON LIFT"

"GAS MONITORING POINT" MOVED

JED 917
LOWPRO 15/10
V6.1

UPDATES TO TOP SURFACE TEXT
DRAFT FOR DISCUSSION

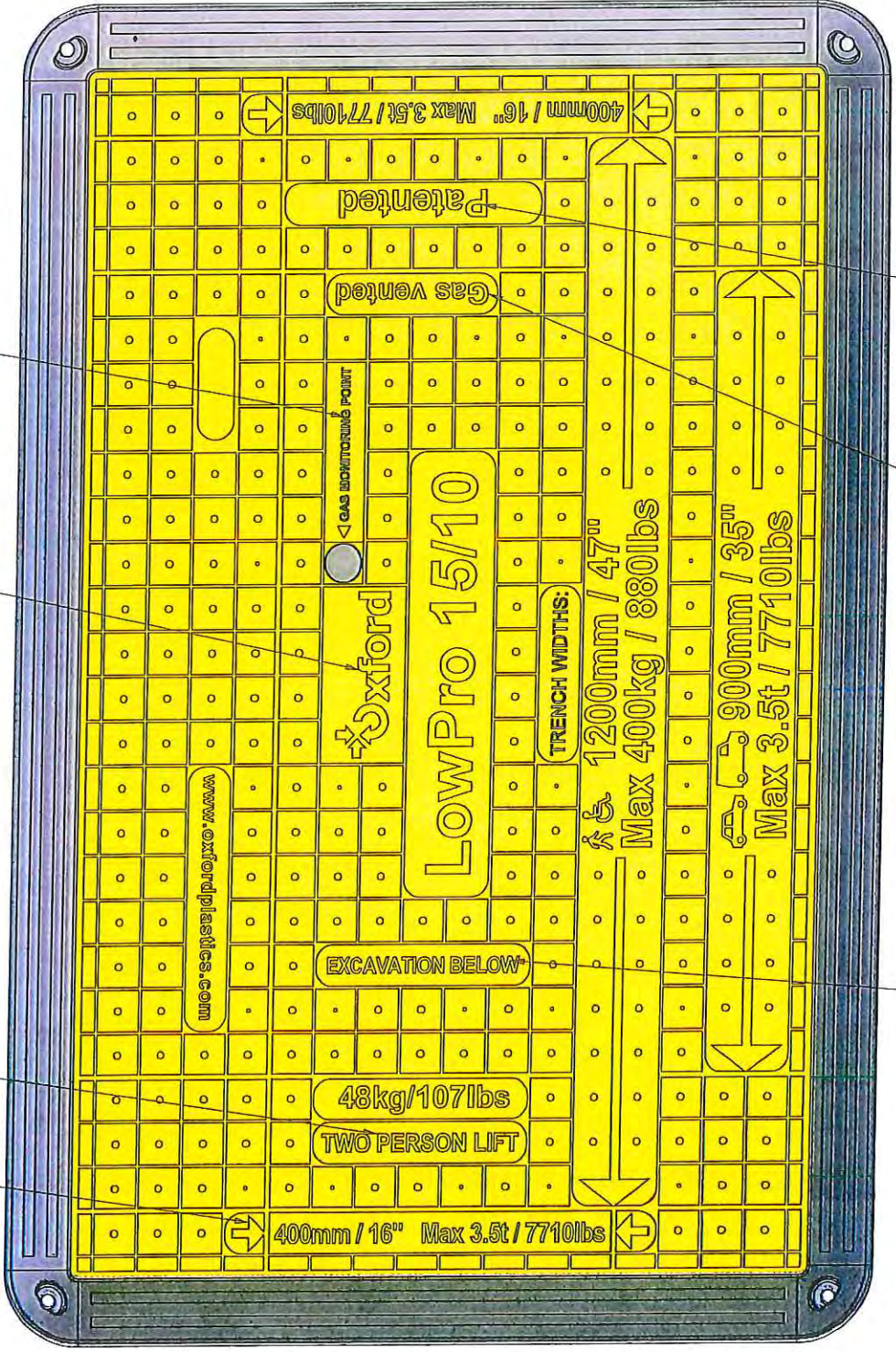

"EXCAVATION BELOW" ADDED INTERCHANGEABLE INSERT

"GAS VENTED" ADDED INTERCHANGEABLE PLATE

TEXT UPDATED TO "PATENTED"

Drawn by: KW
Checked by: EG
CONFIDENTIAL

Issue	Date	Note
1	07/01/2020	

JEDCO
PRODUCT DESIGN

Do not scale
All dimensions in millimetres

© Jedco Product Design for Oxford Plastics
+44 (0)1932 852497 / info@jedco.co.uk

Load Test Report – 1510 LowPro 0063868 – 1200mm Span

Oxford Plastic Systems

(47")

11/03/20

Product Details:

Product type: 1510 LowPro (ID 0063868)
SMC: Menzolit 0390-5317-1023, from production
Rebar: 10mm steel
Product Weight: 38.80kg (including PVC moulding)

Testing Setup

Test Span: 1205mm
Load footprint: 250mm diameter
Load location: centre
Temperature of sample/Temperature of load cell: 8°C/8°C

Testing Process

Load type: Ultimate load testing
Load rate: approximately 250N/s

Performance Requirements – Pedestrian Load

Deflection at 400kg: <60mm
Ultimate load: >800kg
(Derived according to HAUC Advice Note No. 2018/01)

Results

Deflection at 400kg: 9.8mm PASS
Ultimate load: 2900kg PASS

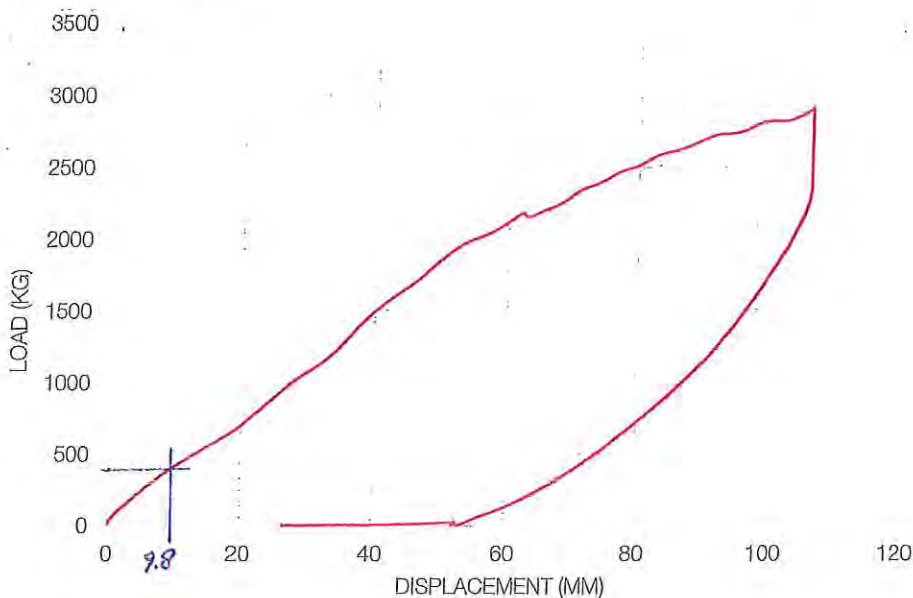

**OXFORD PLASTIC SYSTEMS LLC
MANUFACTURER'S TABULATED DATA
15/10 LOW PRO OXFORD DRIVEWAY PLATE**

PLATE SIZE (FT)	MAX. LOAD (LBS)	MAX. ALLOW. SPAN (FT)	LOAD TYPE
3'-3" x 4'-11" (0.99m x 1.5m)	880	4'-0"	PEDESTRIAN
3'-3" x 4'-11" (0.99m x 1.5m)	7710	3'-0"	VEHICLE

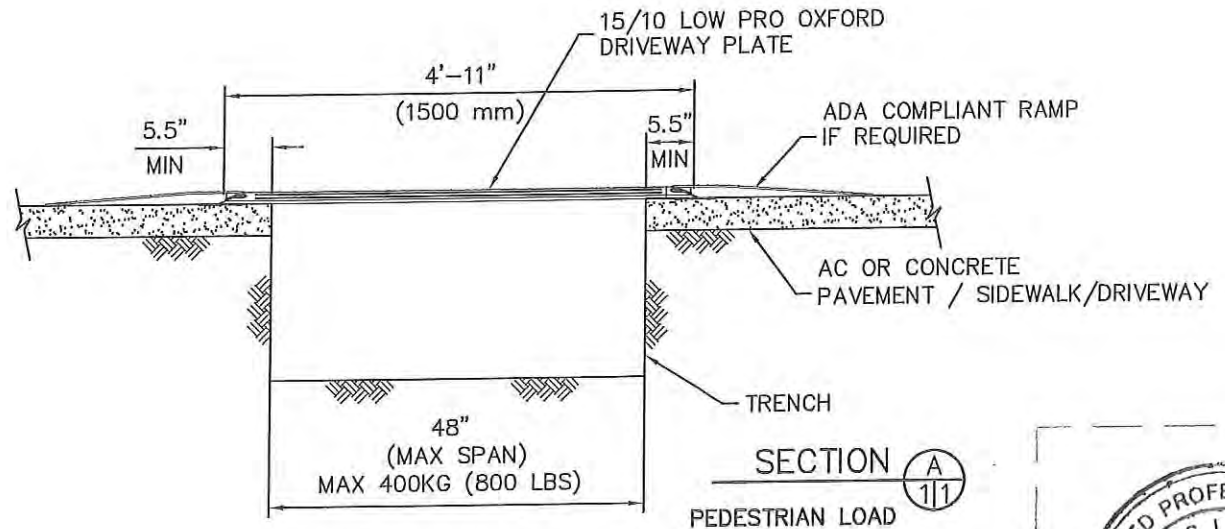
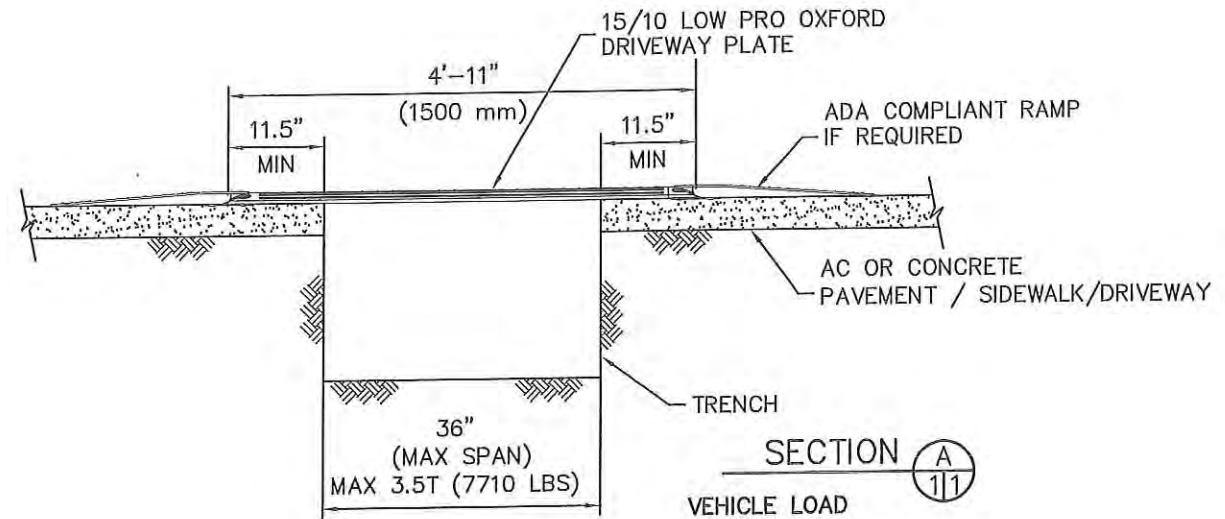
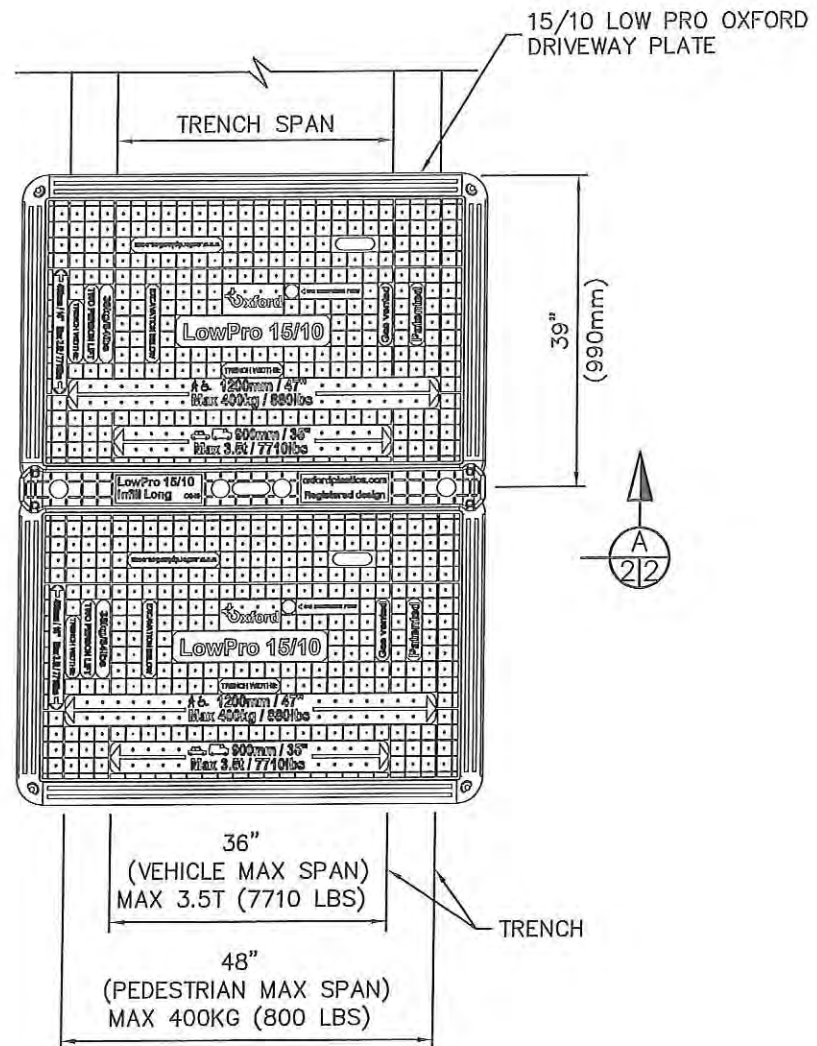

- NOTES:**
1. PLATE MATERIAL TO BE GLASS REINFORCED POLYESTER W/ STEEL REINFORCEMENT.
 2. PLATES ARE DESIGNED FOR PEDESTRIAN LOAD (880 LBS) OR 7710 lb TIRE LOAD.
 3. THE MAX SPAN IS MEASURED FROM ASPHALT OR CONCRETE EDGE TO ASPHALT OR CONCRETE EDGE.
 4. CHART IS BASED ON STABLE TRENCH. STABILITY TO BE DETERMINED BY COMPETENT PERSON OR PROFESSIONAL ENGINEER. SHORING MAYBE REQUIRED.
 5. INSTALL RAMP EDGE FOR ADA COMPLIANT PROJECTS.
 6. SEE MANUFACTURES INFO FOR USE AND GUIDANCE.
 7. THE INSTALLATION OF THE OXFORD PLATES MUST NOT PRESENT A HAZARD TO CYCLISTS OR MOTOR CYCLES.



REVISIONS	BY
05/13/20	AV

OXFORD PLASTIC SYSTEMS LLC
MANUFACTURER TABULATED DATA SHEET
15/10 LOW PRO DRIVEWAY PLATE

OXFORD PLASTIC SYSTEMS LLC
1011 CENTRE ROAD, STE 312
WILMINGTON, DE 19805

J.M. TURNER ENGINEERING, INC.
CONSULTING ENGINEERS
1325 COLLEGE AVE. SANTA ROSA, CA 95404
(707) 528-4503 FAX (707) 528-4505

DATE: 04/27/2020
DRAWN BY: A.B.B.
CHECKED BY: A.J.V.
DRAWING NO: 17682-1/ S1
SHEET: 1 OF 3

REVISIONS	BY
05/13/20	AV

**OXFORD PLASTIC SYSTEMS LLC
MANUFACTURER'S TABULATED DATA
15/10 LOW PRO OXFORD DRIVEWAY PLATE
W/ RAMP EDGE FOR ADA COMPLIANCE**

PLATE SIZE (FT)	MAX. LOAD (LBS)	MAX. ALLOW. SPAN (FT)	LOAD TYPE
3'-3" x 4'-11" (0.99m x 1.5m)	880	4'-0"	PEDESTRIAN
3'-3" x 4'-11" (0.99m x 1.5m)	7710	3'-0"	VEHICLE

OXFORD PLASTIC SYSTEMS LLC
MANUFACTURER TABULATED DATA SHEET
15/10 LOW PRO DRIVEWAY PLATE

OXFORD PLASTIC SYSTEMS LLC
1011 CENTRE ROAD, STE 312
WILMINGTON, DE 19805

J.M. TURNER ENGINEERING, INC.
CONSULTING ENGINEERS
1325 COLLEGE AVE., SANTA ROSA, CA 95404
(707) 528-4503 FAX (707) 528-4505



DATE:	04/27/2020
DRAWN BY:	A.B.B.
CHECKED BY:	A.J.V.
DRAWING NO:	17682-1/S2
SHEET:	2 OF 3

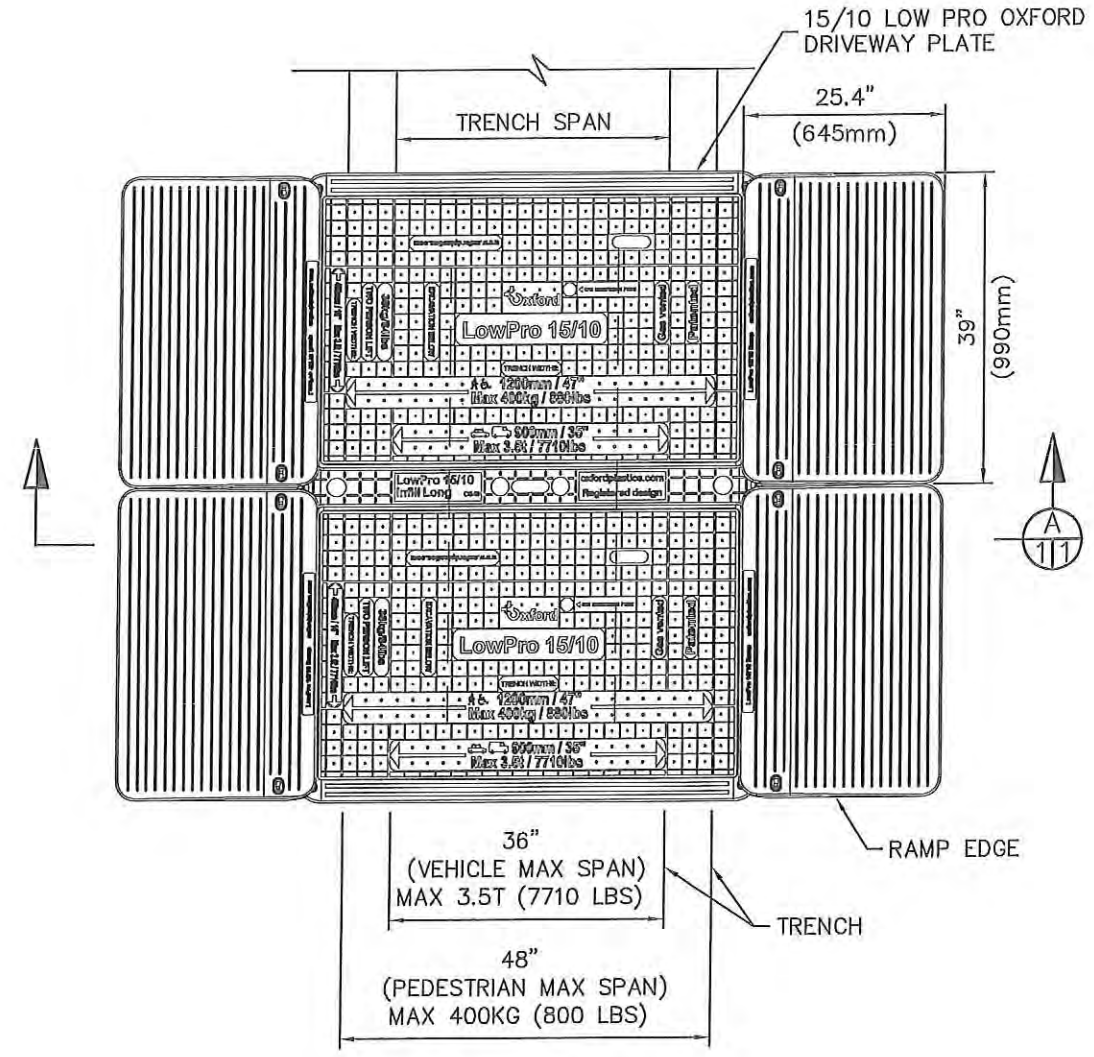

PLAN VIEW

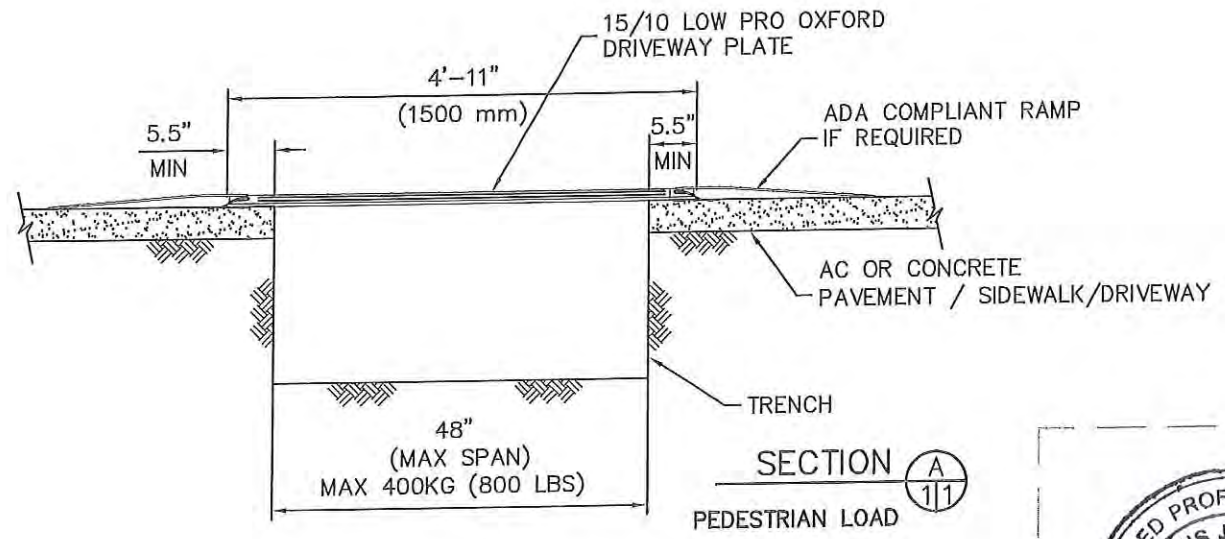
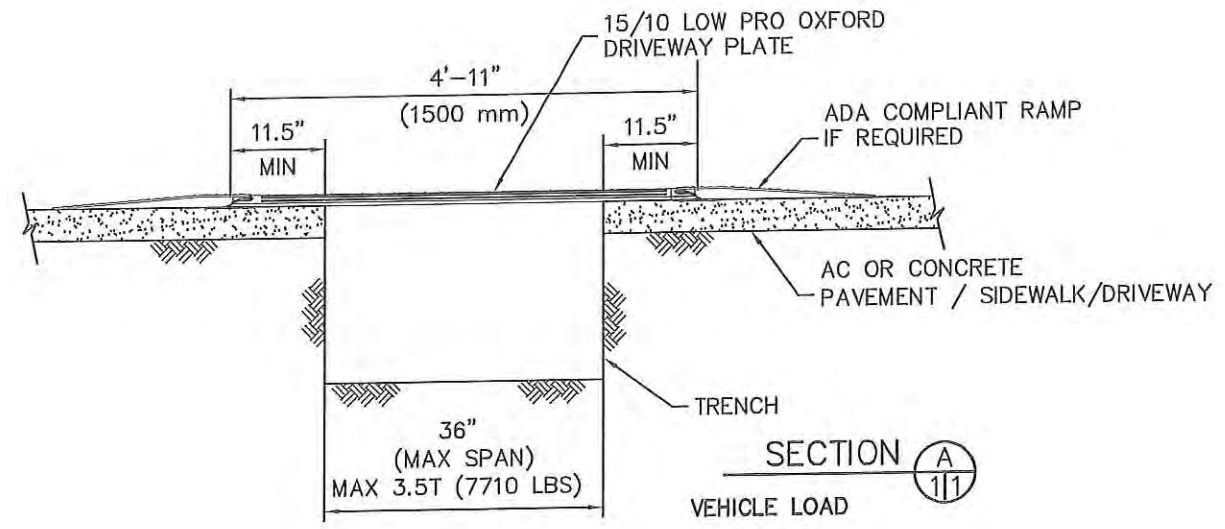

- NOTES:**
1. PLATE MATERIAL TO BE GLASS REINFORCED POLYESTER W/ STEEL REINFORCEMENT.
 2. PLATES ARE DESIGNED FOR PEDESTRIAN LOAD (880 LBS) OR 7710 lb TIRE LOAD.
 3. THE MAX SPAN IS MEASURED FROM ASPHALT OR CONCRETE EDGE TO ASPHALT OR CONCRETE EDGE.
 4. CHART IS BASED ON STABLE TRENCH. STABILITY TO BE DETERMINED BY COMPETENT PERSON OR PROFESSIONAL ENGINEER. SHORING MAYBE REQUIRED.
 5. INSTALL RAMP EDGE FOR ADA COMPLIANT PROJECTS.
 6. SEE MANUFACTURES INFO FOR USE AND GUIDANCE.
 7. THE INSTALLATION OF THE OXFORD PLATES MUST NOT PRESENT A HAZARD TO CYCLISTS OR MOTOR CYCLES.



OXFORD PLASTIC SYSTEMS LLC
 MANUFACTURER'S TABULATED DATA
 15/10 LOW PRO OXFORD DRIVEWAY PLATE

W/ RAMP EDGE FOR ADA COMPLIANCE
 ADDITIONAL CERTIFICATIONS



J.M. Turner Engineering, Inc.
 F-11311

I hereby certify that this plan, specification, or report was prepared by me or under my direct supervision and that I am a duly Licensed Professional Engineer under the laws of the State of Minnesota.

Adrianus J. Vermeulen
 Date 5/13/2020 License # 48822



Dated: 5/13/2020

REVISIONS	BY
05/13/20	AV

OXFORD PLASTIC SYSTEMS LLC
 MANUFACTURER TABULATED DATA SHEET
 15/10 LOW PRO DRIVEWAY PLATE

OXFORD
 PLASTIC SYSTEMS LLC
 1011 CENTRE ROAD, STE 312
 WILMINGTON, DE 19805

J.M. TURNER ENGINEERING, INC.
 CONSULTING ENGINEERS
 1325 COLLEGE AVE. SANTA ROSA, CA 95404
 (707) 528-4503 FAX (707) 528-4505

DATE:	04/27/2020
DRAWN BY:	A.B.B.
CHECKED BY:	A.J.V.
DRAWING NO:	17682-1/S3
SHEET:	3 OF 3