

Cable Pulling Systems



Polykat®

Kati® Blitz Mini

Kati® Blitz Compact 2.0

Kati® Blitz Compact

Kati® Blitz Locating 2.0

Push Rods

Kati® Twist 2.0

Kati® Twist

Cablemax

Mini-Max

Cablejet®

Pipe Eel

Glit®

Cable Guide Heads

Duct Puller

Polykat®

the unique fibreglass profile



the basic element in all
KATIMEX® cable pulling systems

Polykat® fibreglass profiles are the basic elements in all KATIMEX® cable pulling systems.

The **excellent quality** and **versatility** of Polykat® stem from its unique technological design. Polykat® **contains up to 40 % more of glass fibre than conventionell fibreglass duct rodders**. Its particular production technology and special construction enable the combination of these two basically contrary features which are essential for this application.

The more fiberglass of the rod contains, the higher is its stability under shear stress. Polykat® fibreglass profiles therefore contain a particularly large proportion of **high quality glass fibre, of 80 %**.

Cable pulling is simple, quick and precise. The difficulties associated with inserting traditional steel and plastic rods are now once and for all a thing of the past.



Polykat®

Technical Information:

All fibres are embedded together in elastic polyester resin and cross wrapped to form a compact bound core. This forms a wavy, highly resinous outer layer, which takes up the surface tension produced when the rod is bent. This makes a very small radius of curvature possible so that tight bends are easily passed through.

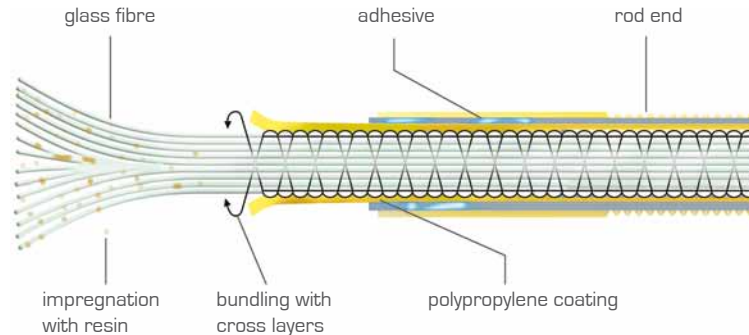

Polykat® fibreglass profiles are basic elements in all KATIMEX® Cable pulling systems

 Kati® Blitz 3,0 mm domestic installation	 Cablemax 4,5 mm underfloor installations	 Cablejet 7,2 mm street lighting & signaling systems	 Pipe Eel 9,0 mm 11,0 mm underground cabling
---	---	--	--

Polykat® fibreglass profile



Polykat® fibreglass profile
 fibreglass core, polypropylene coating
 sold by metre

rod-Ø*	fibreglass core-Ø	breaking load	art.-no.
3.0 mm	2.1 mm	5.0 kN	101115
4.5 mm	3.0 mm	10.3 kN	102013
7.2 mm	5.0 mm	28.0 kN	103195
9.0 mm	6.2 mm	40.0 kN	103198
11.0 mm	7.7 mm	65.0 kN	103199

* further rod-Ø on request

Polykat® fibreglass profile



Polykat® fibreglass profile
 fibreglass core, integrated copper wires, polypropylene coating
 sold by metre

rod-Ø*	fibreglass core-Ø	Cu-wires	breaking load	art.-no.
3.0 mm	2.2 mm	2 x Cu	5.0 kN	101114
4.5 mm	3.0 mm	3 x Cu	10.3 kN	102014
7.4 mm	5.0 mm	6 x Cu	26.0 kN	103192
9.0 mm	6.2 mm	8 x Cu	40.0 kN	103197
11.0 mm	7.7 mm	6 x Cu	65.0 kN	103187

* further rod-Ø on request



KATI® BLITZ MINI

the revolutionary solution for inhouse installation

Optic Fibre-Glass Installation in Buildings



The **KATI® BLITZ MINI** was specifically developed for the installation of subsequent fibre-optic cables in existing as well as occupied tubes.

Where conventional pulling tools are not sufficient anymore, the **KATI® BLITZ MINI** shows its unique possibilities with its 1.2 mm diameter fibreglass profile. Especially the installation of fibre-optic cables in an already existing infrastructure is easier and sometimes even at all possible with the KBM, which makes it the ideal support for the pulling of fibre-optic cables in buildings.

The Polykat® Mini combines high rod rigidity and pushing stability with a very small diameter. With a very small bending radius of 15mm it was specifically developed to run through extremely narrow curves.

The combination of Flexi Sonde Mini and low-friction insertion tube enables a quick and easy cable installation. The Flexi Sonde Mini has a special contour that passes narrow sections and curves easily. The low-friction insertion tube leads the rod and protects it from breakages when pulling back.

Product benefits at a glance:

- Flexi-Sonde Mini: special contour to pass narrow sections and curves
- Rotatable cassette: By spinning the cassette the rod can be pushed easily into conduits
- Axle bearing of the cassette: the high reset force supports the automatic unwinding of the rod.
- Insertion tube: protects and guides the fibreglass while pushing in and prevents it from breaking when pulling back.
- Handling frame with rod-stop: prevents the automatic unwinding of the rod when not in use.



KATI® BLITZ MINI

Technical Data:



The Polykat® Mini fibreglass profile, as well as the spare rods pre-spooled into a cassette are available in 15, 25 and 35 meter versions. Therefore the cassette can be exchanged quick and easy. The rod runs automatically out of the cassette and supports the pushing of the rod. Due to this the physical effort will be minimized.

Rod diameter [mm]	1,2
Proven strength connection Rod/Rod end [kN]	> 0,35
Proven strength of Flexi Sonde Mini [kN]	> 0,25
Minimum bending radius [mm]	15
Breaking strain [kN]	1,3

Kati® Blitz Mini

Polykat® Mini fibreglass profile Ø 1,2 mm rod ends at both ends of the rods.

Accessories included

Accessories included

- 5 Flexi Sonds Mini
- 7 Rod ends Mini
- 1 Tape
- 1 Guiding hose 2,5 m with bush
- 1 Abrasive pad 50 x 50 mm
- 1 Special adhesive 3 g

Kati® Blitz Mini spare rod

Polykat® Mini fibreglass profile Ø 1,2 mm with 2 rod ends and one Flexi Sonde Mini, spooled in a rotating cassette

In a single box: dimensions 124 mm x 120 mm x 31 mm

www.katimex.com



rod length	weight	art.-no.
15 m	0,15 g	101515
25 m	0,18 g	101525
35 m	0,20 g	101535

Our recommendation:

Glit® lubricant

different types for a huge range of applications

- reduces friction during cable pulling up to 90 %
- for all kinds of pulling rods and cables
- Pulling rods can be slid through ducts much more easily with a small amount of Glit® applied to the rod and guide head
- silicone-free, non-flammable, skin-friendly



Scan the QR code and watch the How-To video for the KATI® BLITZ MINI!



Accessories KATI® BLITZ MINI

Accessories-Set



Accessories-Set

5 Flexi-Sondes Mini, 5 Rod ends Mini, 1 special adhesive 3 g,
1 abrasive pad 50 x 50 mm, 1 guiding hose 2,5 m, 1 tape 15 mm

PU = 1 Set in plastic bag

PU	weight	art.-no.
1	83 g	101271

Service-Set



Service-Set

10 Rod ends Mini, 1 special adhesive 3 g, 1 abrasive pad 50 x 50 mm,
1 tape 15 mm

PU = 1 Set in a plastic bag

PU	weight	art.-no.
1	51 g	101270

Flexi-Sonde Set



Flexi-Sonde Set

with internal thread M 2,5

PU = 5 pieces in a blister

PU	weight	art.-no.
1	16 g	101275

Rod end Set



Rod end Set

brass, with external thread M 2,5

PU = 5 pieces in a blister

PU	weight	art.-no.
1	2 g	101277

Guiding hose



Guiding hose

low-friction hose with adjustment bush, fitted at the hose

PU = 1 piece in a plastic bag

PU	weight	art.-no.
1	83 g	101276



KATIMEX®

Kati® Blitz Compact 2.0

The future of pulling systems

New design -
extended function



Katimex sets new standards in pulling devices by introducing the **Kati® Blitz Compact 2.0** to the market.

Katimex professionals and electricians further developed the well-known devices Kati® Blitz Compact, Locating and Vario and thoroughly tested and examined the new device.

Kati® Blitz Compact 2.0 is the ideal tool for professionals. It is characterized by its **improved, ergonomic design**, user-friendly handling and practice-approved functions. The **handy crank** for the 20 and 30 m version makes the winding of the Polykat® fibreglass very easy.

The combination of both Flexi-Sonde 2.0 and Rod End 2.0 enables a very narrow **bending radius of just 30 mm**. The rod guide is reinforced with fibreglass that makes it extremely wear-resistant. The specific return stop protects the rod from gliding into the box accidentally while winding.

A service box **with lots of accessories** and the reliable high Katimex quality accomplish the Kati® Blitz compact 2.0 and make it an indispensable tool for electrical engineers.

All existing accessories of the Kati® Blitz product range are compatible with the Kati® Blitz compact 2.0.

Watch our
product video:





Kati® Blitz Compact 2.0

Technical Information:



The **Kati® Blitz Compact 2.0** has a handy crank in the 20 und 30 meter version for winding the rod quickly into the casing. The rod can be pulled out of the casing easily by hand. The 50 m version has **no** crank.

rod diameter [mm]	3,0	
tensile strength of connection rod/rod end [kN]	1,0	
minimum radius of curvature [mm]	30	
breaking strength of rod [kN]	5,0	

rod length	weight	art.-no.
20 m	1,1 kg	101620
30 m	1,2 kg	101630
50 m	1,4 kg	101650

Kati® Blitz is available in different versions

Kati® Blitz Compact 2.0

Polykat® fibreglass profile
Ø 3,0 mm

Rod End 2.0 at both ends

Integrated accessories box with lift-up lid

Accessories included

Accessories supplied:

- 5 pulling eyes Ø 6 mm, brass with M5 thread
- 1 cable grip with integral swivel for Ø 6-9 mm cables
- 2 Rod Ends 2.0 with external M5 thread
- 3 splices, brass
- 1 special adhesive (3g)
- 1 Flexi-Sonde 2.0 Ø 7 mm
- 1 Flexi-Sonde 2.0 Ø 10 mm

The accessories are compatible with all products of the Kati® Blitz- and Cabelmax- range as well as with the Push Rods Profi-Set.



Find all accessories in the Product Overview
Accessories for Kati® Blitz

Locating

Kati® Blitz

is also available as locating device

Further information can be found in our catalogue **Locating Devices** or at:

www.katimex.com

Kati® Blitz spare rod

Polykat® fibreglass profile
Ø 3 mm with 2 rod ends 2.0, external M5 thread, 1 flexible guide head Ø 7 mm, 1 pulling eye

www.katimex.com

Kati® Blitz spare rod Ø 3 mm

rod length	weight	art.-no.
20 m	300 g	101320
30 m	400 g	101330
50 m	600 g	101350

Our recommendation:

Glit® Lubricant

different formulations available designed to match the type of application

- reduces friction during cable pulling up to 90 %
- for all kinds of pulling rods and cables
- put it on the cable sheathing while pulling the cable in
- silicone-free, non-flammable, skin-friendly
- put it in the guide head already before you insert the Polykat® in the conduit

IMPROVED FORMULA



art.-no. 101370

Kati® Blitz

cable pulling device for domestic installation

unbeatable in design and use



The **Kati® Blitz** was the first device of its kind in the world. It is perfectly designed to pull cables into conduits even under the most difficult conditions.

Kati® Blitz compact easily gets through long winding tracks and in pipe systems where cables have previously been laid. It still works where other pulling devices have already failed.

Since its introduction **Kati® Blitz** has proved its worth in daily use with hundred thousands of electricians around the world.

The combination of a functional box and our unique **Polykat® fibreglass profile** allows to wind the rod in and out quickly without knotting or loops forming.

Threaded rod ends are attached at both ends of the rod, to which cable grips, pulling eyes or guide heads can be attached simply.

Now with
Rod End 2.0



Watch our
product video:



The **Rod End 2.0** improves the bending of the **Polykat® fibreglass profile** at the interface between rod and rodend. It does not only minimize the danger of breaking the rod but does also allow a more narrow minimal bending radius of 30 mm.





Kati® Blitz

Technical Information:



The patented housing of **Kati® Blitz** provides a safe and easy storage of the fiberglass profile without rotating outside parts. It is available with rod lengths of 20, 30 or 50 m. The robust, solid housing has an accessories box with a lift-up lid.

rod diameters [mm]	3.0	
tested tensile strength of connection rod/end [kN]	1.0	
minimum rad. of curvature [mm]	50	
breaking strain of rod [kN]	5.0	

rod length	weight	art.-no.
20 m	1.08 kg	101820
30 m	1.18 kg	101830
50 m	1.37 kg	101850

Different types of **Kati® Blitz** are available

Kati® Blitz compact

Polykat® fibreglass profile Ø 3.0 mm
rod ends at both ends
integrated accessories box with lift-up lid
carrying grip

accessories included

Accessories supplied:

- 2 flexible guide heads Ø 7 mm & 10 mm
- 5 pulling eyes Ø 6 mm, brass with M5 thread
- 1 Kati® Grip Powerdisk
- 1 cable grip with integral swivel for Ø 6-9 mm cables
- 5 rod ends, brass with M5 thread
- 3 splices, brass
- 1 special adhesive (3 g)



find all accessories in the Product Overview **Accessories for Kati® Blitz**

Locating

Kati® Blitz

is also available as locating system

Find more information in our Catalogue under **Locating Systems** or at:

www.katimex.com

Spare rod for Kati® Blitz

2 rod ends 2.0, external M5 thread, inkl. 1 flexibel guide head Ø 7 mm, 1 pulling eye Ø 6 mm, brass with external thread M5

www.katimex.com

Spare rod for Kati® Blitz Ø 3 mm

rod length	weight	art.-no.
20 m	1.80 kg	101420
30 m	2.00 kg	101430
50 m	2.10 kg	101450

Our recommendation:

Glit® Lubricant

different formulations available designed to match the type of application

- reduces friction during cable pulling up to 90 %
- for all kinds of pulling rods and cables
- Pulling rods can be slid through ducts much more easily with a small amount of Glit® applied to the rod and guide head
- silicone-free, non-flammable, skin-friendly

IMPROVED FORMULA



Art.-Nr. 101370



Accessories for Kati® Blitz

Kati® Blitz Pulling rod



Polykat® fibreglass profile Ø 3.0 mm

rod ends 2.0 at both ends, incl. 1 Ø 7 mm guide head and 1 pulling eye Ø 6 mm, brass with external thread M5

dimensions 245 mm x 245 mm x 45 mm

rod length	weight	art.-no.
20 m	300 g	101320
30 m	400 g	101330
50 m	600 g	101350

Pulling Rod Locating



Polykat® fibreglass Ø 3,0 mm with copper wire

rod ends 2.0 at both ends, incl. 1 Ø 7 mm guide head and 1 pulling eye Ø 6 mm, brass with external thread M5

dimensions 245 mm x 245 mm x 45 mm

rod length	weight	art.-no.
20 m	300 g	104320
30 m	400 g	104330
50 m	600 g	104350

Cable Grip



Cable Grip with integral swivel

high tensile galvanized steel strand, back woven, M5 threaded connection

max. permitted load with a safety factor of 1,5

cable-Ø (mm)	breaking load (kN)	pulling force (kN)	working meshlength (mm)	weight (g)	art.-no.
4 - 6	2.0	1.3	100	5	108066
6 - 9	2.0	1.3	120	5	108060
9 - 12	2.0	1.3	180	10	108061
12 - 15	2.0	1.3	230	20	108062

Cable Grip



Cable Grip with integral pulling eye

high tensile galvanized steel strand, back woven, M5 threaded connection

max. permitted load with a safety factor of 1,5

cable-Ø (mm)	breaking load (kN)	pulling force (kN)	working meshlength (mm)	weight (g)	art.-no.
4 - 6	2.0	1.3	100	5	108076
6 - 9	2.0	1.3	120	5	108070
9 - 12	2.0	1.3	180	10	108071
12 - 15	2.0	1.3	230	20	108072
15 - 19	8.1	5.4	280	30	108063
19 - 25	11.7	7.8	290	45	108064
25 - 31	18.5	12.3	300	75	108065

Cable Grip



Cable Grip with one eye

high tensile galvanized steel strand, back woven

max. permitted load with a safety factor of 1,5

cable-Ø (mm)	breaking load (kN)	pulling force (kN)	working meshlength (mm)	weight (g)	art.-no.
4 - 6	2.0	1.3	100	5	108181
6 - 9	2.0	1.3	120	5	108182
9 - 12	2.0	1.3	180	15	108183
12 - 15	2.0	1.3	230	25	108187
15 - 19	8.1	5.4	280	40	108184
19 - 25	11.7	7.8	290	60	108185
25 - 31	18.5	12.3	300	95	108186



Accessories for Kati® Blitz

Rod End 2.0



Rod End 2.0 for fibreglass profile Ø 3,0 mm

Brass-rod end with a flexible plastic sheathing, external M5 thread

1 PU = 5 pieces in plastic bag

PU	weight	art.-no.
1	15 g	101047

Kati® Blitz Service set 2.0



Kati® Blitz Service set 2.0

3 rod ends 2.0, brass, external thread M5, 5 pulling eyes, 3 splices

1 special adhesive 3 g, repair instruction

	weight	art.-no.
in a plastic bag	45 g	101246

Kati® Blitz Service set



Kati® Blitz Service set

3 rod ends 2.0 with external thread, 5 pulling eyes, 3 splices

1 special adhesive 3 g, repair instruction

	weight	art.-no.
in a plastic bag	45 g	101245

Special adhesive



Special adhesive

for Polykat® fibreglass profile up to Ø 6 mm

low viscosity

content	weight	art.-no.
3 g	5 g	101027
20 g	30 g	103211

Flexi-Sonde 2.0



Flexi-Sonde 2.0

Flexi-Sonde 2.0, plastic, inner thread M5

1 PU = 3 pieces in a plastic bag

PU	diameter	weight	art.-no.
1	1 x 7 mm, 1 x 10 mm, 1 x 13 mm	60 g	101078
1	7 mm	30 g	101075
1	10 mm	50 g	101076
1	13 mm	60 g	101077

Flexible guide head set

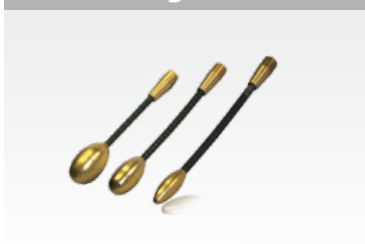

Flexible guide heads

brass, with readjusting spring, internal thread M5

1 PU = 3 pieces in a plastic bag

PU	diameter	weight	art.-no.
1	7 mm	30 g	101033
1	10 mm	45 g	101034
1	13 mm	60 g	101035
1	Set, 7, 10, 13 mm	45 g	101042



Accessories for Kati® Blitz

Splice



Splice for fiberglass profile Ø 3.0 mm
brass

1 PU = 10 pieces in a plastic bag

PU	weight	art.-no.
1	35 g	101015

Pulling eye



Pulling eye
brass, Ø 6 mm, internal M5 thread

1 PU = 10 pieces in a plastic bag

PU	weight	art.-no.
1	30 g	101017

Rod end



Rod end for fiberglass profile Ø 3.0 mm
brass, with external M5 thread

1 PU = 10 pieces in a plastic bag

PU	weight	art.-no.
1	30 g	101016

Easy Grip



Easy Grip
Manual advancing device consists of a high-tech, hard-wearing plastic.
The handy pulling device has an ergonomic shape.
Dimensions 126 mm x 53 mm x 40 mm

tensile load max.	weight	art.-no.
20 kg	90 g	101070

Kati® Grip Powerdisk



Kati® Grip Powerdisk
pulling rubber, for quick and easy pulling of fiberglass rod and cables up to Ø 6 mm

weight	art.-no.
50 g	101364



Recommended extension

Driving unit



Driving unit for Kati® Blitz

with tongue / flexible tube for motor-driven
insertion of fibreglass profiles up to Ø 3 mm & 4,5 mm via drilling machine
- also available with optional length counter

Description	weight	art.-no.
Driving unit for Kati® Blitz	0.30 kg	101816
Driving unit with length counter	0.40 kg	101817

Glit®



Glit® Cable lubricant

new formula reduces friction during cable pulling up to 90 %

silicone-free, skin-friendly, non-flammable

content	packaging *	weight	art.-no.
200 ml	tube	0.24 kg	101370
1 L	bucket	1.20 kg	101373
5 L	bucket	5.30 kg	101374

* find more packaging sizes in our Glit® Prospect or at www.katimex.com



Kati® Blitz Locating 2.0

The next generation of pulling systems with locating capacity

One device -
two applications



The **Kati® Blitz Locating 2.0** is the successor of the established cable pulling and locating device Kati® Blitz 2in1. Equipped with an internal slip ring transformer and a high quality Polykat® fibreglass profile with integrated copper wires allows the installer to pull cable, to locate blockades and to follow the route of the pipe. Kati® Blitz Locating 2.0 can be used with all customary cable detectors.

Similar to the Kati® Blitz Compact 2.0 the Kati® Blitz Locating 2.0 has an **improved, ergonomic design** and a user friendly handling.

The **handy crank** of the 20 and 30 m version makes the winding of the Polykat® fibreglass profile very easy. Furthermore the combination of both Flexi-Sonde 2.0 and Rod End 2.0 enables a very narrow **bending radius of just 30 mm**.

The rod guide is reinforced with fibreglass that makes it extremely wear-resistant. The specific return stop protects the rod from gliding into the box accidentally while winding.

A service box **with lots of accessories** and the reliable high Katimex quality accomplish the Kati® Blitz Locating 2.0 and make it an indispensable tool for electrical engineers.

All existing accessories of the Kati® Blitz product range are compatible with the Kati® Blitz Locating 2.0.

Watch our
how-to video:





Kati® Blitz Locating 2.0

Technical Information:



The **Kati® Blitz Locating 2.0** has a handy crank in the 20 und 30 meter version for winding the rod quickly into the casing. The rod can be pulled out easily by hand. The 50 m version has **no** crank.

rod diameter [mm]	3,0
tensile strength of connection rod/rod end [kN]	1,0
minimum radius of curvature [mm]	30
breaking strength of rod [kN]	5,0

rod length	weight	art.-no.
20 m	1,15 kg	104620
30 m	1,25 kg	104630
50 m	1,50 kg	104650

Kati® Blitz Locating 2.0 is available in different versions

1 Kati® Blitz Locating 2.0

Polykat® fibreglass profile
Ø 3,0 mm

Rod End 2.0 at both ends

Integrated accessories box with lift-up lid

[Accessories included](#)

Accessories supplied:

- 5 pulling eyes Ø 6 mm, brass with M5 thread
- 1 cable grip with integral swivel for Ø 6-9 mm cables
- 2 Rod Ends 2.0 with external M5 thread
- 3 splices, brass
- 1 special adhesive (3g)
- 1 Flexi-Sonde 2.0 Ø 7 mm
- 1 Flexi-Sonde 2.0 Ø 10 mm

The accessories are compatible with all products of the Kati® Blitz- and Cabelmax-range as well as with the Push Rods Profi-Set.



find all accessories in the Product Overview
[Accessories for Kati® Blitz](#)

2 Polykat® fibreglass profile

for Kati® Blitz Locating 2.0 assembled with Rod Ends 2.0 including a flexible guide head Ø 7 mm and a pulling eye

www.katimex.com

Cable detector

Kati® Blitz Locating 2.0 can be used with all customary cable detectors.

Spare rod for Kati® Blitz Locating 2.0

rod length	weight	art.-no.
20 m	300 g	104320
30 m	400 g	104330
50 m	600 g	104350

Our recommendation:

Glit® Lubricant

different formulations available designed to match the type of application

- reduces friction during cable pulling up to 90 %
- for all kinds of pulling rods and cables
- put it on the cable sheathing while pulling the cable in
- silicone-free, non-flammable, skin-friendly
- put it in the guide head already before you insert the Polykat® in the conduit

IMPROVED FORMULA



art.-no. 101370



Push Rods

The new push rod system made by KATIMEX® - Pushes you to the solution!

quick - handy - perfect



KATIMEX® push rods are indispensable for a quick and easy cable installation where no empty conduits, cable duct or any other cable guiding exists.

The innovative gliding support does not only slide over obstacles – due to an integrated LED light it also illuminates the workspace. The handy and sturdy bag is comfortable and user friendly. It is easily attachable to every ladder – so the push rods are always within reach.

Because of the different diameters and bending radii the push rods are adaptable case of application. Cables and ropes can be as well pushed as pulled.

The abrasion-proof plastic sheathing ensures that the high quality fiberglass is not damaged in everyday work.

integrierbare
LED-Leuchte



Technical Information:



Das Schubstangen Profiset besteht aus 7 Schubstangen Ø 8 mm und 3 Schubstangen Ø 6 mm. Sie sind jeweils 1 m lang und lassen sich perfekt kombinieren und beliebig erweitern.

Typ	Gewicht	Art-Nr.
Profi-Set	1600 g	106270

Push Rods Profi-Set

contains 10 push rods.

Accessories supplied:

- 1 gliding support
- 1 LED-Light
- 1 hook
- 1 chain
- 1 super-Magnet
- 1 changer M6 to M5
- 1 guidinghead with ring
- 1 guidinghead
- 1 pulling eye
- 1 flex-rod (15 cm)



Further accessories can be found on
www.katimex.com

Many
Accessories



Push rods extension-set „Profi“

	weight	art.-no.
3 rods Ø 6 mm / 3 rods Ø 8 mm	1090 g	106271

Accessories-Set „Profi“

	weight	art.-no.
Gliding support, LED-light, hook, chain, super-magnet, guidinghead with ring, guidinghead without ring, pulling eye, flex-rod	250 g	106292

Service-Set „Profi“

	weight	art.-no.
2 x rod end Ø 8 mm with external thread M 6 2 x rod end Ø 8 mm with internal thread M 6 1 x rod end Ø 6 mm with external thread M 6 1 x rod end Ø 6 mm with internal thread M 6 1 x special adhesive for Polykat® 20 g	100 g	106291

Cable Grip



Cable grip with integral pulling head

high tensile galvanised steel strand, back woven, M5 screw connection

Max. permitted load with a safety factor of 1.5

cabel-Ø (mm)	breaking- load (kN)	pulling- force (kN)	working mesh-length	weight (g)	art.-no.
4 - 6	2,0	1,3	100	5	108076
6 - 9	2,0	1,3	120	5	108070
9 - 12	2,0	1,3	180	10	108071
12 - 15	2,0	1,3	230	20	108072
15 - 19	8,1	5,4	280	30	108063
19 - 25	11,7	7,8	290	45	108064
25 - 31	18,5	12,3	300	75	108065



Kati® Twist 2.0

smoothly through
tubes and conduits



At a glance:

- ✓ extra short rod end for passing extremely tight bending radii
- ✓ compatible with the complete range of accessories of the Kati® Blitz or Cablemax
- ✓ Time-saving winding and unwinding thanks to the crank function
- ✓ pull-in rods can be easily repaired by the user
- ✓ easy to use for right and left-handers
- ✓ integrated pulling grip in the handle

With the new Kati® Twist 2.0 Katimex® closes the gap between Perlon rods and the high-quality Polykat® fibreglass profiles. Katimex® offers the perfect pulling system for any kind of tube or installation.

The modern design and impact-resistant plastic housing additionally offers the function of easy and quick winding. This also means great time saving for the user before or after pulling the cable and also reduces the risk of accidents which could occur due to unwinded rod on the floor.

Thanks to the M5 thread, the Kati Twist is compatible with the complete range of accessories of the Kati Blitz and Kabelmax. The extra short Rod End allows extremely tight bending radii. The 3-fold twisted Perlon rod has a high tensile strength. Tensile loads up to 130 kg [tape/rod end] are possible without any problems.

Like all Katimex® products, the twisted rod of the Kati® Twist 2.0 can also be repaired by the user.

Accessories supplied with Kati® Twist 2.0

- 1 Pulling Grip Kati® Twist 2.0
- 1 flexible guide head with pulling eye, thread M5, Ø 7 mm
- 1 pulling eye, brass with M5 thread, Ø 6 mm



Kati® Twist 2.0

Technical informations



Thanks to the M5 thread, the Kati Twist is compatible with the complete range of accessories of the Kati Blitz and Kabelmax. The extra short Rod End allows extremely tight bending radii. The 3-fold twisted Perlon rod has a high tensile strength. Tensile loads up to 130 kg (tape/rod end) are possible without any problems. Like all Katimex® products, the twisted rod of the Kati® Twist 2.0 can also be repaired by the user.

rod-Ø	rod length	weight	art.no.
4,5 mm	20 m	1,5 kg	102520
4,5 mm	30 m	1,9 kg	102530

rod diameter [mm]	4,5
tube diameter [mm]	16 to 32
min. bending radius [mm]	100
breaking strain of rod [kN]	2,5
proved tensile strength of adhesive connection [belt/sleeve] [kN]	1,3

Pulling rod



Kati® Twist 2.0 spare rod

Twisted synthetic rod, Ø 4,5mm, pressed ferrule M6 Ø 8mm on both sides, 1 guide head Ø 7mm with pulling eye M5, 1 Pulling eye

rod-Ø	rod length	weight	art.no.
4,5 mm	20 m	0,4 kg	102521
4,5 mm	30 m	0,6 kg	102531

Guide Head



Flexible Guide Head

Thread M5, Ø 7 mm, brass

title	selling unit	art.no.
Flexible guide head with pulling eye	1 piece	101058

Accessories Set



Kati® Twist Accessories Set

2 rod ends, 1 pulling eye Ø 11 mm, 3 pulling eyes with M5 thread, 1 cable grip with swivel for Ø 6 - 9 mm cables, 1 flexible guide head Ø 10 mm

title	selling unit	art.no.
Accessories Set Ø 4,5 mm	1 SU = 1 set	101253

Service Set



Kati® Twist 2.0 Service Set

The service set for the Kati® Twist contains 3 Rod Ends 4,5 mm

title	selling unit	art.no.
Service Set Ø 4,5 mm	1 SU = 1 set	101250

Pulling Grip



Pulling Grip Kati® Twist 2.0

title	selling unit	art.no.
Pulling Grip for Kati® Twist 2.0	1 piece	101368

Kati® Twist

smoothly through tubes and conduits

robust and reliable



Katimex® cable pulling systems are made of the best technical components. Our new addition to the well-known and value proved Polykat® fibreglass profile is the Kati® Twist series. Katimex® provides the right pulling system solution for each conduit and any kind of cable laying challenges. The specific outside contour of the Kati® Twist spiral rod enables outstanding bending and gliding characteristics. The rod shows a significantly enhanced overall push and pull performance comparing to traditional Nylon or steel rods.

The Kati® Twist has a sturdy, galvanized steel tube frame that houses the steel winder for the twisted fibreglass profile. Like the Cablemax® the Kati® Twist possesses a fine adjustable brake to prevent the Kati® Twist profile from uncontrolled reeling under its own tension. Because of the M5 rod end all Cablemax® or Kati® Blitz accessories can be used with the Kati® Twist as well. Both ends of the rod got a short rod end that enables quick and simple passing through tight bows.

The Kati® Twist rod impresses with excellent tensile strength. A tensile load up to 200 kg (rod/rod end) is possible. And, like all Katimex® products, the Kati® Twist rod can be repaired by the user.

Accessories supplied with Kati® Twist:

- 1 flexible guide head Ø 10 mm
- 1 pulling eye Ø 6 mm, brass with M5 thread
- 2 rod ends, brass with M5 thread

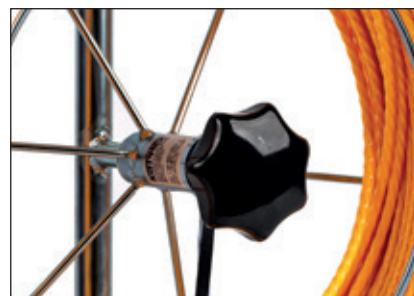

Technical information



Kati® Twist

rod-Ø	rod length	weight	art.no.
4,5 mm red	25 m	2,3 kg	102541
5,2 mm yellow	20 m	2,3 kg	102550
5,2 mm yellow	40 m	2,5 kg	102551
6,0 mm black	40 m	2,6 kg	102560

rod diameter [mm]	4,5	5,2	6,0
breaking strain of rod [kN]	3,0	4,0	5,5
proved tensile strength of adhesive connection (belt/sleeve) [kN]	2,0	2,0	2,0

Accessories supplied: 1 flexible guide head Ø 10 mm
 1 pulling eye Ø 6 mm, brass with M5 thread
 2 rod ends, brass with M5 thread

Pulling rod

Pulling rod for Kati® Twist including

1 flexible guide head Ø 10 mm, 1 pulling eye Ø 6 mm, brass with M5 thread, 2 rod ends, brass, with M5 thread



rod-Ø	rod length	weight	art.no.
4,5 mm red	15 m	0,35 kg	102540
4,5 mm red	25 m	0,60 kg	102545
5,2 mm yellow	20 m	0,60 kg	102555
5,2 mm yellow	40 m	0,70 kg	102556
6,0 mm black	40 m	0,80 kg	102565

Accessories Set



Kati® Twist Accessories Set

2 rod ends, 1 pulling eye Ø 11 mm, 3 pulling eyes with M5 thread, 1 cable grip with swivel for Ø 6 - 9 mm cables, 1 flexible guide head Ø 10 mm

rod-Ø	weight	art.-no.
4,5 mm	45 g	101253
5,2 mm	45 g	101254
6,0 mm	45 g	101255

Service Set



Kati® Twist Service Set

The service set for the Kati® Twist contains 3 Rod Ends

rod-Ø	weight	art.-no.
4,5 mm	10 g	101250
5,2 mm	10 g	101251
6,0 mm	10 g	101252

Our recommendation:



Glit® Lubricant

Reduces friction during cable pulling up to 90 %. Glit® is the optimal lubricant for all common coating materials. New technologies allow the production of ecologically friendly greases, that meet the high demands when pulling cables. The use of Glit® is especially recommended when working over long distances, in heavily occupied ducts or under floor channels.

Art.-Nr. 101370



Cablemax

underfloor cable pulling system

the expert for
underfloor installations



The conduit snake **Cablemax** was specially developed for installations in offices, department stores and industrial buildings.

The unique **Polykat® fibreglass profile** combines the shear strength of a grid pole with the flexibility required in everyday practice. Up to 80 m fibreglass profile are stored in the devices aluminium cage on smallest spaces. A flexible special shaped guide head screwed onto the rod slides past all cables in the conduit without getting caught up.

Even heavy occupied underfloor systems can be passed through easily. The universal screw connection allows the use of the same accessories as for the Kati® Blitz. Guide heads and cable grips can be connected in variable configurations.

Due to the new **service bag** all the accessories are attached to the device and at the job site.



Cablemax

Technical Information:



The **Cablemax** has a **sturdy steel tube frame** in which the **aluminium storage basket** for the fibreglass profile is housed. Up to 80 m of rod can be stored here, saving a lot of space.

A light adjustable brake prevents the **Polykat® fibreglass profile** from reeling out of the basket under its own tension. Rod ends with M5 thread at both ends of the rod make it possible to work in both directions. Guide heads and cable grips can be connected simply and quickly.

rod diameter [mm]	4.5
tested tensile strength of connection rod/end [kN]	1.5
minimum rad. of curvature [mm]	100
breaking strain of rod [kN]	10.3

Different types of **Cablemax** are available

Cablemax®

Polykat® fibreglass profile \varnothing 4.5 mm
rod ends at both ends
galvanized steel tube frame
aluminium storage basket

included / without accessories

Accessories supplied:

- 1 service bag
- 1 guide head with pulling eye \varnothing 11 mm, brass with M5 thread
- 2 pulling eyes \varnothing 6 mm, brass with M5 thread
- 3 rod ends, brass with M5 thread
- 2 splices, brass
- 1 special adhesive (3 g)

1 & 2

Cablemax M10

fitted with rod end M10 (internal),
suitable for locating sonde of
Radiodetection Systems

without accessories

* available on request

optional*

Cablemax

is also available as locating
system

Find more information in our
catalogue under
Locating Systems or at:

www.katimex.de

locating

1 accessories included

rod length	weight	art.-no.
40 m	6.0 kg	102044
60 m	6.4 kg	102046
80 m	7.0 kg	102048

2 without accessories

rod length	weight	art.-no.
40 m	6.0 kg	102024
60 m	6.4 kg	102026
80 m	7.0 kg	102028



find all accessories for this product
Overview **Accessories for Cablemax**

Our recommendation:

Glit® Lubricant

different formulations available designed
to match the type of application

- reduces friction during cable pulling up to 90 %
- for all kinds of pulling rods and cables
- Pulling rods can be slid through ducts much more easily with a small amount of Glit® applied to the rod and guide head
- silicone-free, non-flammable, skin-friendly



art.-no. 101370



Mini-Max

underfloor cable pulling system

MINIMUM of weight and size,
MAXIMUM of application comfort



Like its „big brother“ **Cablemax**, **Mini-Max** was specially developed for installations in offices, department stores and industrial buildings.

The tool´s stands out due to its **extreme light weight**. Furthermore it convinces of the cages small diameter of 30 cm and 5 cm width. Its **suitable mounted grip** gives an excellent handling and makes the device slightly wider. **The highlight:** Mini-Max can simply be fitted to a belt and **both hands will remain free!**

The unique **Polykat® fibreglass profile** combines the **shear strength of a grid pole** with the flexibility required in everyday practice. Up to 40 m fibreglass profile are stored in the devices cage on smallest space. A flexible special shaped guide head fitted to the front of the rod slides past all cables in the conduit without getting caught up.

Even heavy occupied underfloor systems can be passed through **easily**.
Guide heads and cable grips can be connected in variable configurations.



Mini-Max

Technical Information:

Mini-Max consists of a light, mobile cage with handle. The integrated brake prevents the **Polykat® fibreglass rod** from reeling out of the basket under its own tension.



rod diameter [mm]	4.5
tested tensile strength of connection rod/end [kN]	1.5
minimum rad. of curvature [mm]	100
breaking strain of rod [kN]	10.3

Accessories supplied: 1 guide head with pulling eye, Ø 11 mm,
2 rod ends, installed

rod length	weight	art.-no.
40 m	1.4 kg	102940

Mini-Max - efficient, compact and manageable

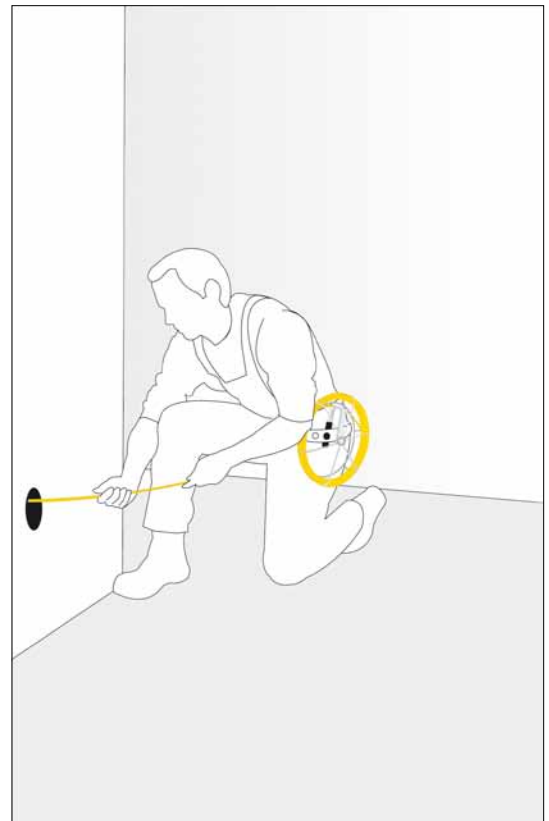
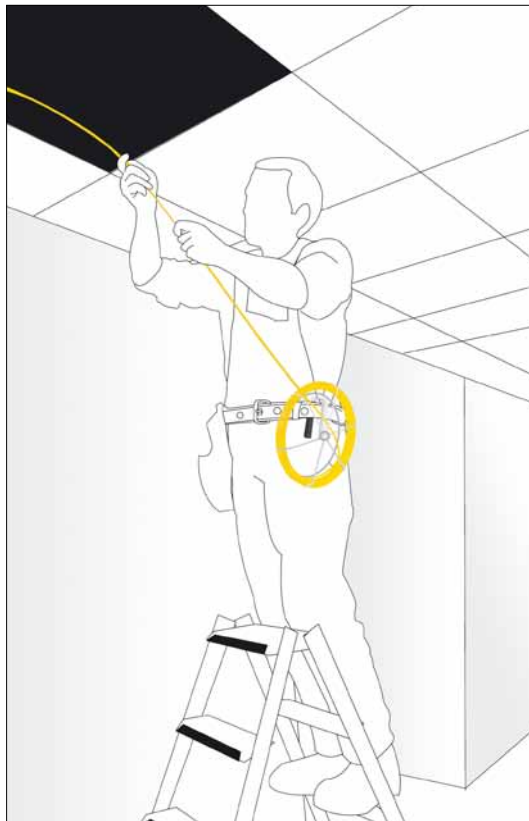

The ideal tool for time saving laying of cables even under difficult conditions.

Find all accessories in the Product Overview Accessories for Cablemax or at www.katimex.com



Accessories for Cablemax

Cablemax Pulling rod



Polykat® fibreglass profile Ø 4.5 mm

rod ends at both ends, incl. 1 guide head with pulling eye Ø 11 mm, 1 pulling eye M5 threaded.

dimensions 400 mm x 400 mm x 70 mm

rod length	weight	art.-no.
40 m	1.3 kg	102034
60 m	1.7 kg	102036
80 m	2.1 kg	102038

Cable Grip



Cable Grip with integral swivel

high tensile galvanized steel strand, back woven, M5 threaded connection

max. permitted load with a safety factor of 1.5

cable-Ø (mm)	breaking load (kN)	pulling force (kN)	working meshlength (mm)	weight (g)	art.-no.
4 - 6	2.0	1.3	100	5	108066
6 - 9	2.0	1.3	120	5	108060
9 - 12	2.0	1.3	180	10	108061
12 - 15	2.0	1.3	230	20	108062

Cable Grip



Cable Grip with integral pulling eye

high tensile galvanized steel strand, back woven, M5 threaded connection

max. permitted load with a safety factor of 1.5

cable-Ø (mm)	breaking load (kN)	pulling force (kN)	working meshlength (mm)	weight (g)	art.-no.
4 - 6	2.0	1.3	100	5	108076
6 - 9	2.0	1.3	120	5	108070
9 - 12	2.0	1.3	180	10	108071
12 - 15	2.0	1.3	230	20	108072
15 - 19	8.1	5.4	280	30	108063
19 - 25	11.7	7.8	290	45	108064
25 - 31	18.5	12.3	300	75	108065

Cable Grip



Cable Grip with one eye

high tensile galvanized steel strand, back woven

max. permitted load with a safety factor of 1.5

cable-Ø (mm)	breaking load (kN)	pulling force (kN)	working meshlength (mm)	weight (g)	art.-no.
4 - 6	2.0	1.3	100	5	108181
6 - 9	2.0	1.3	120	5	108182
9 - 12	2.0	1.3	180	15	108183
12 - 15	2.0	1.3	230	25	108187
15 - 19	8.1	5.4	280	40	108184
19 - 25	11.7	7.8	290	60	108185
25 - 31	18.5	12.3	300	95	108186

Kati® Grip Powerdisk



Kati® Grip Powerdisk

pulling rubber, for quick and easy pulling of fibreglass profile and cables up to Ø 6 mm

weight	art.-no.
50 g	101364

Accessories for Cablemax

Kati® Grip



Kati® Grip

patented, ergonomically styled pliers made of strong resilient plastic, reduces wear on the rod, for all pulling systems up to 4.5 mm rod diameter

dimensions 185 mm x 55 mm x 20 mm

weight	art.-no.
125 g	101369

Flexible guide head set



3 Flexible guide heads

brass, with readjusting spring, internal thread M5

1 VE = 3 pieces in a plastic bag

VE		weight	art.-no.
1	7 mm	30 g	101033
1	10 mm	45 g	101034
1	13 mm	60 g	101035
1	Set, 7, 10, 13 mm	45 g	101042

Cablemax Service bag



with Cablemax Service set

5 rod ends, 1 guide head with pulling eye, 3 splices

1 special adhesive 3 g, repair instruction

weight	art.-no.	
In a plastic bag	50 g	102086

Cablemax Service set



Cablemax Service set

5 rod ends, 1 guide head with pulling eye, 3 splices

1 special adhesive 3 g, repair instruction

weight	art.-no.	
In a plastic bag	50 g	102055

Guide head



Guide head with pulling eye

brass, internal thread M5

1 VE = 3 pieces in a plastic bag

diameter	weight	art.-no.
11 mm	45 g	102018

Pulling eye



Pulling eye

brass, internal thread M5

1 VE = 10 pieces in a plastic bag

diameter	weight	art.-no.
6 mm	30 g	101017



Accessories for Cablemax

Rod end



Rod end for fibreglass profile Ø 4.5 mm
brass, external thread M5

1 VE = 10 pieces in a plastic bag

weight	art.-no.
30 g	102017

Splice



Splice for fibreglass profile Ø 4.5 mm
brass

1 VE = 10 pieces in a plastic bag

weight	art.-no.
50 g	102008

Special adhesive



Special adhesive

for Polykat® fibreglass profile up to Ø 6 mm

low viscosity

content	weight	art.-no.
3 g	5 g	101027
20 g	30 g	103211

Glit®



Glit® Cable lubricant

new formula reduces friction during cable pulling up to 90 %

silicone-free, skin-friendly, non-flammable

content	packaging*	weight	art.-no.
200 ml	tube	240 g	101370
1 L	bucket	1200 g	101373
5 L	bucket	5300 g	101374

* find more packaging sizes in our Glit® Prospect or at www.katimex.com

Recommended extension

Driving unit



Driving unit Cablemax

with tongue / flexible tube for motor-driven
insertion of fibreglass profiles up to \varnothing 3 mm & 4.5 mm via drilling machine
- also available with optional length counter

description	weight	art.-no.
Driving unit for Cablemax	270 g	102021
Driving unit with length counter	360 g	102022

Length counter



Length measuring device for cablemax

for simple and quick measuring of ducts. No inefficient marking, pacing out or
measuring is required and accurate results are achieved using the length counter.

Abmessung 100 mm x 50 mm x 160 mm

Description	Weight	art.-no.
Length measuring device for cabelmax	300 g	102020



Cablejet

variable cable pulling system

light, handy & compact



Within the **KATIMEX**[®] product range, the innovative **Cablejet** lies between the popular **Cablemax** and **Pipe Eel** products.

For many years the Cablejet has been used extensively by **electrical construction companies**, **cable laying specialists** and **power supply contractors**. The Cablejet has been used for news network cabling, **street lighting** and **signaling systems** and civil engineering projects where power cables are laid.

The **Polykat**[®] fibreglass profile with $\text{Ø } 7,2 \text{ mm}$ provides **high push force stability** and **flexibility**.

One **special model** is suitable for the **location in non-conducting pipes**.

With its **folding frame**, the **Cablejet** is surprisingly compact and it can be fitted comfortably into a car for transportation. This **compact design** also means that when storing the cablejet **valuable space can be saved**.

The **robust and sturdy design** ensures that the Cablejet is ideal for working on site, the **stable, corrosion proof steel construction** and **large footprint** ensures that the Cablejet can be used safely and efficiently in such working conditions.

Due to the new **service bag** all the accessories are attached to the device and at the job site.



Cablejet

Technical Information:



The **Cablejet** is made with a corrosion-proof steel tube construction. The basket has a special store and bearings and can hold up to 120 m of **Polykat®** fibreglass profile.

An integral brake ensures that the Polykat® fibreglass profile reels out of the basket as desired. Glued and bolted rod ends with a **M12 thread** at both ends of the rod make it possible to **work in both directions** so that guide heads, cable grips or special accessories such as detection devices can be screwed on easily and in variable configurations.

KATIMEX® offers a wide range of additional accessories designed to match the type of special working conditions.

rod diameter (mm)	7.2
tested tensile strength of connection rod/end (kN)	7.5
minimum rad. of curvature (mm)	190
breaking strain of rod (kN)	28.0

Different types of **Cablejet** are available

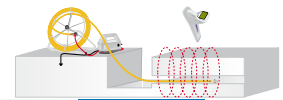

Cablejet

Polykat® fibreglass profile **Ø 7,2mm**
rod ends at both ends
folding frame, galvanized steel tube construction
integrated brake
integrated rod guiding device

accessories included

Accessories supplied:

- 1 service bag
- 1 guide head with pulling eye Ø 25 mm, aluminium
- 1 shackle, bolt-Ø 10 mm
- 2 rod ends
- 1 splice
- 4 dowel pins
- 1 special adhesive (20 g)

1

optional*

Cablejet M10

fitted with rod end M10 (internal), suitable for locating sonde of Radiodetection Systems

without accessories

*see recommended extension

Cablejet

is also available as locating system

Find more information in our catalogue under **Locating Systems** or at:

www.katimex.com

locating

1 accessories included

rod length	weight	art.-no.
40 m	7.8 kg	103502
60 m	9.2 kg	103504
80 m	10.2 kg	103506
100 m	11.5 kg	103508
120 m	12.0 kg	103509

Our recommendation:

Glit® Lubricant

different formulations available designed to match the type of application

- reduces friction during cable pulling up to 90 %
- for all kinds of pulling rods and cables
- Pulling rods can be slid through ducts much more easily with a small amount of Glit® applied to the rod and guide head
- silicone-free, non-flammable, skin-friendly



find all accessories in the **Product Overview for Cablejet**





Accessories for Cablejet

Cablejet Pulling rod



Polykat® fibreglass profile Ø 7.2 mm

2 rod ends with M12 thread, incl. 1 guide head with pulling eye Ø 25 mm and shackle dimensions 640 mm x 640 mm x 70 mm

rod length	weight	art.-no.
40 m	3.4 kg	103552
60 m	4.7 kg	103554
80 m	6.0 kg	103556
100 m	7.1 kg	103558
120 m	10.4 kg	103559

Cable Grip



Cable Grip with one eye

high tensile galvanized steel strand, back woven

cable-Ø (mm)	breaking load (kN)	pulling force (kN)	working mesh length* (mm)	weight (kg)	art.-no.
10 - 20	18.8	9.4	900	0.25	108000
20 - 30	22.6	11.3	900	0.35	108001
30 - 40	37.0	18.5	900	0.50	108002
40 - 50	55.0	27.5	900	0.80	108003
50 - 65	55.0	27.5	900	0.85	108004

max. permitted load with a safety factor of 2

* refers to the mounted cable grip

find more Cable Grips in our Prospect **Cable Grips for Underground Cabling** or at www.katimex.com

Swivel



Swivel

with double axial bearing, stainless steel

diameter (mm)	length (mm)	max. tension* (kN)	breaking load (kN)	weight (kg)	art.-no.
16	64	3.3	10.0	0.06	107183
20	78	5.0	15.0	0.12	107173
22	86	10.0	30.0	0.15	107174
25	98	15.6	47.0	0.23	107175
32	121	22.2	67.0	0.45	107176
35	130	31.1	93.0	0.63	107177
38	143	40.0	120.0	0.77	107184
41	152	44.5	133.0	0.95	107181

* max. tension with a safety factor of 3 for horizontal tension

find more Swivels in our brochure **Swivels** or at www.katimex.com

Swivel connector



Swivel connector

galvanized steel, with M12 threaded connections at both ends, for connecting two fibreglass profiles

Ø	length	weight	art.-no.
30 mm	85 mm	0.36 kg	103212

Guide head



Guide head

for ducts from Ø 100 mm, aluminium with internal M12 thread

Ø	length	weight	art.-no.
40 mm	80 mm	0.18 kg	103207

Accessories for Cablejet

Guide head



Guide head with pulling eye

aluminium, with internal M12 thread

diameter	bore-Ø	length	weight	art.-no.
18 mm	11 mm	55 mm	20 g	103208
25 mm	13 mm	60 mm	40 g	103206

Shackle



Shackle with smooth bolt, shape B

according to DIN 82101 with flat head screw, galvanized
(except 100493)

bolt-Ø	max. tensile strength	frame-Ø	clear width	weight	art.-no.
10 mm	4.0 kN	8 mm	14 mm	85 g	100491
12 mm	6.3 kN	10 mm	17 mm	195 g	100494
16 mm	10 kN	13 mm	21 mm	360 g	100495
20 mm	16 kN	17 mm	27 mm	750 g	100496
22 mm	20 kN	19 mm	30 mm	1000 g	100497
36 mm	50 kN	30 mm	47 mm	4000 g	100498

Cablejet Service bag



with Cablejet Service set

2 rod ends with external M12 thread, 1 splice, 1 special adhesive 20 g,
4 dowel pins, repair instruction

	weight	art.-no.
in a plastic bag	300 g	103596

Cablejet Service set



Cablejet Service set

2 rod ends with external M12 thread, 1 splice, 1 special adhesive 20 g,
4 dowel pins, repair instruction

	weight	art.-no.
in a plastic bag	120 g	103595

Rod end



Rod end for fibreglass profile Ø 7.2 mm

brass with external M12 thread

length	weight	art.-no.
40 mm	40 g	103249
fitting spring pin		103595

Splice



Splice for fibreglass profile Ø 7.2 mm

brass

length	weight	art.-no.
50 mm	20 g	103487
spring pins	PU 10 pieces	103593



Accessories for Cablejet

Special adhesive



Special adhesive

for Polykat® fibreglass profiles larger than Ø 6 mm

high viscosity

content	weight	art.-no.
20 g	30 g	103210

Duct cleaning brush



Duct cleaning brush

synthetic or steel wire brush, pulling eyes attached at both ends

duct-Ø	brush	weight	art.-no.
80 mm	synthetic	0.6 kg	103218
100 mm	synthetic	1.2 kg	103219
80 mm	steel	0.5 kg	103220
100 mm	steel	1.1 kg	103221

Duct cleaning brush

with herical steel wires. *no image

duct-Ø	spiralling	weight	art.-no.
100 mm	left	1.3 kg	103250
100 mm	right	1.3 kg	103251

Coupling device



Coupling device

robust aluminium construction, maintenance free coupling cage with special coupling mechanism

diameter	tensile load capacity	length	weight	art.-no.
78 mm	3 kN	210 mm	0.9 kg	103280

Glit® F200



Glit® F200 high performance cable lubricant for underground cabling

for heavy cables and long pulls, friction can be reduced more than 50 %

silicone-free, skin-friendly, non-flammable

content	packaging *	weight	art.-no.
10 L	canister	10.4 kg	101376
20 L	canister	20.7 kg	101377
30 L	canister	31.3 kg	101378

* find more packaging sizes in our Glit® Prospect or at www.katimex.com

Recommended extension

Length counter



Length counter for Cablejet

for simple and quick measuring of underground ducts or pipes no inefficient marking, pacing out or measuring is required and accurate results are achieved using the length counter

dimensions 120 mm x 115 mm x 110 mm

	weight	art.-no.
Length counter for Cablejet	0.7 kg	103049

Recommended extension

Sondesystem



Sondesystem

Transmitter for tracking in non-metallic conduits and pipes.

Battery-operated, with thread M10. In combination with M12/M10 adapter suitable for all Cablejet and Pipe Eel devices with external M12 thread.

type	max. depth	diameter	weight	art.-no.
Transmitter	up to 4 m	18 mm	0.10 kg	104047
Transmitter	up to 5 m	39 mm	0.20 kg	104068
Adapter Ø 18 mm		22 mm	0.03 kg	104048
Adapter Ø 39 mm		42 mm	0.12 kg	104069

Locating Devices

Locating Devices

for point and route location

Point and route analysis can be primarily undertaken using this universal locating system. A sonde is attached to the equipment at the beginning of the fibreglass rod which can be located easily thanks to a particularly strong magnetic field. Point location is used for locating defective points in pipeline systems such as blockages, sunken sections of pipe etc. The transmitter is connected to the connection box via two cables (see illustration). Route location is used for tracking entire pipe courses. The transmission takes place along the entire length of the fibreglass profile. This version has the advantage compared with simple „pig transmitters“ that only one person is required for locating work and losing the signal is excluded.

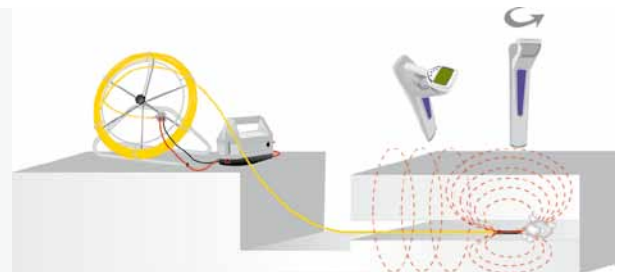

Locating Devices

for route locating

Route location can be used for tracking of entire pipe courses. The transmission cable is connected between transmitter and locating rodder. The second connection of the transmitter is earthed (see illustration).

This fibreglass rod contains one or more copper wires that

emit a **locatable signal** over the **entire band length** via the connection of the transmitter.

This signal can be picked up, dependent on the transmission and receiving equipment and local and structural circumstances, **down to a depth of several meters**.

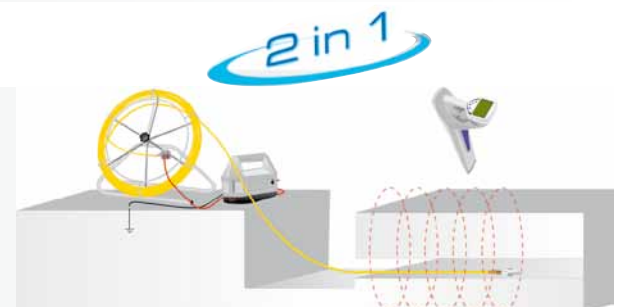

Jet with Sondesystem



Locating Device for Point and Route Locating

Polykat® fibreglass Ø 7.4 mm with integrated copper wires

sonde for end point determination, connection box with socket and pins for two connections, galvanized steel frame and reel Ø 650 mm

rod length	rod-Ø	weight	art.-no.
30 m	7,4 mm	7.5 kg	104070
60 m	7,4 mm	9.6 kg	104073
90 m	7,4 mm	11.7 kg	104076
120 m	7,4 mm	13.8 kg	104077



Pipe Eel

cable pulling system for underground engineering

*the expert for telecommunication
and power cable laying*



The **Pipe Eel (Röhrenaal®)** - often referred to as duct rodder, has a quality frame of galvanized steel tube construction which is screwed together.

Pipe Eel was introduced in 1974 as the world's first cable pulling device to be equipped with a **high-quality Polykat®** fibreglass profile. The combination of **stability under shear stress and flexibility** was a considerable improvement on traditional cable pulling aids. Work was made so much easier as the Pipe Eel was **very light and easy to use** and soon became popular with telecom engineers and for power cabling on construction sites. Today, as then the device allows the pulling of **light and medium duty cables in one simple run**.

Attachments such as cable grips or pulling eyes can be connected with both ends of the rod.

Cables and winching wires are pulled into ducts, conduits, cable protection piping or cable swivel connector. In this way cable and wire can be pulled over twice the distance.

The **advantages** of using the Pipe Eel have grown continually with the addition of more innovative accessories and attention to detail. An **integral brake** prevents the Polykat® fibreglass profile from reeling out of the basket under its own tension. The **ergonomic shape** makes it and with its compact design, it can easily be transported by car to site.

Due to the new **service bag** all the accessories are attached to the device and at the job site.



Pipe Eel

Technical Information:



The **duct rodder** Pipe Eel - Röhrenaal® is a corrosion proof, completely galvanized steel tube construction. The cage itself has special bearings and the largest type Ø 1000 mm can take up to 500 m Polykat® fibreglass profile. An integral brake ensures that the **Polykat® fibreglass profile** reels out of the basket as desired. Glued and bolted rod ends with a **M12 thread** at both ends of the rod make it possible to **work in both directions** so that guide heads, cable grips or special accessories such as detection devices can be screwed on easily and in variable configurations.

KATIMEX® offers a wide range of additional accessories designed to match the type of special working conditions.

rod diameter [mm]	9	11
tested tensile strength of connection rod/end [kN]	10	15
minimum rad. of curvature [mm]	240	390
breaking strain of rod [kN]	40	65

Different types of **Pipe Eel** are available

1 Pipe Eel 9 mm

Basket-Ø 750 mm
Polykat® fibreglass profile Ø 9 mm
up to 150 m length
rod ends M12 at both ends
galvanized tube construction
integral brake

accessories included

Accessories supplied:

- 1 service bag
- 1 guide head with pulling eye Ø 25 mm, aluminium
- 1 shackle, bolt-Ø 10 mm
- 2 rod ends
- 1 splice
- 4 dowel pins
- 1 special adhesive (20 g)



find all accessories in the **Product Overview for Pipe Eel**

2 Pipe Eel 11 mm

Basket-Ø 1000 mm
Polykat® fibreglass profile Ø 11 mm
up to 500 m Length
rod ends M12 at both ends
galvanized tube construction
integral brake

accessories included (q. v. 9 mm)

Optional*

Pipe Eel M10

fitted with rod end M10 (internal), suitable for locating sonde of Radiodetection Systems

without accessories

*see recommended extension

1 Pipe Eel 9 mm

rod length	weight	art.-no.
40 m	16 kg	103004
60 m	18 kg	103006
80 m	19 kg	103008
100 m	20 kg	103010
120 m	23 kg	103012
150 m	26 kg	103014

2 Pipe Eel 11 mm

rod length	weight	art.-no.
120 m	33 kg	103017
150 m	37 kg	103015
180 m	42 kg	103016
200 m	44 kg	103020
250 m	51 kg	103025
300 m	58 kg	103030
350 m	62 kg	103035
400 m	71 kg	103040
450 m	74 kg	103045
500 m	80 kg	103048



Accessories for Pipe Eel

Pipe Eel Pulling rod



Polykat® fiberglass profile Ø 9 mm

2 rod ends with M12 thread, incl. 1 guide head with pulling eye Ø 25 mm and shackle

rod length	weight	art.-no.
40 m	3.6 kg	103070
60 m	5.7 kg	103072
80 m	7.0 kg	103074
100 m	9.6 kg	103076
120 m	11.0 kg	103078
150 m	14.3 kg	103079

Pipe Eel Pulling rod



Polykat® fiberglass profile Ø 11 mm

2 rod ends with M12 thread, incl. 1 guide head with pulling eye Ø 25 mm and shackle

rod length	weight	art.-no.
120 m	17 kg	103080
150 m	20 kg	103081
180 m	24 kg	103082
200 m	28 kg	103086
250 m	36 kg	103091
300 m	41 kg	103096
350 m	43 kg	103097
400 m	55 kg	103098
450 m	57 kg	103099
500 m	60 kg	103100

Cable Grip



Cable Grip with one eye

high tensile galvanized steel strand, back woven

cable-Ø (mm)	breaking load (kN)	pulling force (kN)	working mesh length* (mm)	weight (kg)	art.-no.
10 - 20	18.8	9.4	900	0.22	108000
20 - 30	22.6	11.3	900	0.35	108001
30 - 40	37.0	18.5	900	0.50	108002
40 - 50	55.0	27.5	900	0.80	108003
50 - 65	55.0	27.5	900	0.85	108004

max. permitted load with a safety factor of 2

* refers to the mounted cable grip

find more Cable Grips in our Prospect **Cable Grips for Underground Cabling** or at www.katimex.com

Swivel



Swivel

with double axial bearing, stainless steel

diameter (mm)	length (mm)	max. tension* (kN)	breaking load (kN)	weight (kg)	art.-no.
16	64	3.3	10.0	0.06	107183
20	78	5.0	15.0	0.12	107173
22	86	10.0	30.0	0.15	107174
25	98	15.6	47.0	0.23	107175
32	121	22.2	67.0	0.45	107176
35	130	31.1	93.0	0.63	107177
38	143	40.0	120.0	0.77	107184
41	152	44.5	133.0	0.95	107181
51	178	66.7	200.0	1.70	107178
60	262	110.0	330.0	3.50	107182
76	349	222.0	667.0	7.70	107179

* max. tension with a safety factor of 3 for horizontal tension

find more Swivels and Accessories in our brochure **Swivels** or at www.katimex.com

Accessories for Pipe Eel

Swivel Connector



Swivel connector

galvanized steel, with M12 threaded connections at both ends, for connecting two fibreglass profiles

diameter	length	weight	art.-no.
30 mm	85 mm	360 g	103212

Guide head



Guide head

for ducts from Ø 100 mm, aluminium with internal M12 thread

diameter	length	weight	art.-no.
40 mm	80 mm	180 g	103207

Guide head



Guide head with pulling eye

aluminium, with internal M12 thread

diameter	bore-Ø	length	weight	art.-no.
18 mm	11 mm	55 mm	20 g	103208
25 mm	13 mm	60 mm	40 g	103206

Shackle



Shackle with smooth bolt, shape B

according to DIN 82101 with flat head screw, galvanized
(except 100493)

bolt-Ø	max. tensile strength	frame-Ø	clear width	weight	art.-no.
10 mm	4.0 kN	8 mm	14 mm	85 g	100491
12 mm	6.3 kN	10 mm	17 mm	195 g	100494
16 mm	10 kN	13 mm	21 mm	360 g	100495
20 mm	16 kN	17 mm	27 mm	750 g	100496
22 mm	20 kN	19 mm	30 mm	1000 g	100497
36 mm	50 kN	30 mm	47 mm	4000 g	100498

Pipe Eel Service set



with Pipe Eel Service set

2 rod ends with external M12 thread, 1 splice, 1 special adhesive 20 g
4 dowel pins, repair instruction

	rod-Ø	weight	art.-no.
in a plastic bag	9 mm	350 g	103140
in a plastic bag	11 mm	400 g	103141

Pipe Eel Service set



Pipe Eel Service set

2 rod ends with external M12 thread, 1 splice, 1 special adhesive 20 g
4 dowel pins, repair instruction

	rod-Ø	weight	art.-no.
in a plastic bag	9 mm	140 g	103138
in a plastic bag	11 mm	150 g	103139



Accessories for Pipe Eel

Rod end



Rod end for fiberglass profile Ø 9 mm
brass with external M12 thread

length	weight	art.-no.
72 mm	40 g	103200
spring pins	PU 10 pieces	103133

Rod end



Rod end for fiberglass profile Ø 11 mm
brass with external M12 thread

length	weight	art.-no.
72 mm	35 g	103202
spring pins	PU 10 pieces	103133

Splice



Splice for fiberglass profile Ø 9 mm
brass

length	weight	art.-no.
80 mm	45 g	103203
spring pins	PU 10 pieces	103133

Splice



Splice for fiberglass profile Ø 11 mm
brass

length	weight	art.-no.
80 mm	45 g	103205
spring pins	PU 10 pieces	103133

Special adhesive



Special adhesive
for Polykat® fiberglass profile larger than Ø 6 mm
high viscosity

content	weight	art.-no.
20 g	30 g	103210

Duct cleaning brush



Duct cleaning brush
synthetic or steel wire brush, pulling eyes attached at both ends

duct-Ø	brush	weight	art.-no.
80 mm	synthetic	0.6 kg	103218
100 mm	synthetic	1.2 kg	103219
80 mm	steel	0.5 kg	103220
100 mm	steel	1.1 kg	103221

Accessories for Pipe Eel

Duct cleaning brush



Duct cleaning brush

with flat spiral steel wire brush, pulling eyes attached at both ends
length approx. 500 mm

duct-Ø	spiralling	weight	art.-no.
100 mm	left	1.30 kg	103250
100 mm	right	1.30 kg	103251

Coupling device



Coupling device

robust aluminium construction, maintenancefree coupling cage with special coupling mechanism

diameter	tensile load capacity	length	weight	art.-no.
78 mm	3 kN	210 mm	0.90 kg	103280

Glit® F200



Glit® F200 high performance cable lubricant for underground cabling

for heavy cables and long pulls, friction can be reduced more than 50%

silicone-free, skin-friendly, non-flammable

content	packaging*	weight	art.-no.
10 L	canister	10.40 kg	101376
20 L	canister	20.70 kg	101377
30 L	canister	31.30 kg	101378

* find more packaging sizes in our Glit® Prospect or at www.katimex.com

Recommended extension

Length counter



Length counter for Pipe Eel

for simple and quick measuring of underground ducts or pipes.

No inefficient marking, pacing out or measuring is required and accurate results are achieved using the length counter.

dimensions 120 mm x 115 mm x 110 mm

description	weight	art.-no.
Length counter for Pipe Eel	0.70 kg	103050

Sondesystem



Sondesystem

Transmitter for tracking of non-metallic conduits and pipes.

Battery-operated, with thread M10. In combination with M12/M10 adapter suitable for all Cablejet and Pipe Eel devices with M12 thread.

type	max. depth	diameter	weight	art.-no.
Transmitter	up to 4 m	18 mm	0.10 kg	104047
Transmitter	up to 5 m	39 mm	0.20 kg	104068
Adapter Ø 18 mm		22 mm	0.03 kg	104048
Adapter Ø 39 mm		42 mm	0.12 kg	104069



Glit®
Cable lubricant

**IMPROVED
FORMULA**



*different formulations available
designed to match every type of application*

NEW - the improved formula

Glit® lubricants are available in a wide range of different formulations to match nearly every type of application. Its new formula **reduces friction during cable pulling up to 90 %**.

Glit® is the optimal lubricant for all common coating materials.

New technologies allow the production of **ecologically friendly greases**, that meet the high demands when pulling cables

The use of **Glit®** is especially recommended when working over long distances, in heavily occupied ducts or under floor channels. It can be used in small quantities as it spreads very easily.

Glit® has proved its worth in daily use for years.

Silicone-free, skin-friendly, non-flammable

Advice: For further information please refer to the material safety data sheet.



Glit®

Glit®



Glit® is our proven lubricant for domestic installations

It is optimized for the usage with our Kati® Blitz and Cablemax. Its new formula reduces friction during cable pulling considerable.



content	packaging	weight	art.-no.
200 ml	tube	0.24 kg	101370
200 ml/tube	10 tubes/display box	2.54 kg	101371
1 L	bucket	1.10 kg	101373
5 L	bucket	5.20 kg	101374
10 L	bucket	10.60 kg	101375

Glit® F100



Glit® F100 is a proven high performance lubricant for cable installations where longer pulling distances and higher pulling speeds are typically encountered

content	packaging	weight	art.-no.
1 L	bottle	1.10 kg	101384
5 L	canister	5.20 kg	101385
10 L	canister	10.20 kg	101386
20 L	canister	20.70 kg	101387
30 L	canister	33.00 kg	101388

Glit® F200



Glit® F200 is a proven high performance lubricant which is used for cable installation projects with heavy cables and long pulls

content	packaging	weight	art.-no.
10 L	canister	10.40 kg	101376
20 L	canister	20.70 kg	101377
30 L	canister	31.30 kg	101378
60 L	barrel	65.00 kg	101379

Glit® Blue



Glit® Blue is a proven high performance lubricant which is used for cable installations with heavy cables and short to medium long pulls

content	packaging	weight	art.-no.
10 L	canister	10.20 kg	101380
20 L	canister	20.70 kg	101381
30 L	canister	33.00 kg	101382

Glit® Air



Glit® Air is a proven high performance lubricant used with air-assisted cable blowing and pushing systems

content	packaging	weight	art.-no.
1 L	bottle	1.10 kg	101390
5 L	canister	5.20 kg	101391
10 L	canister	10.20 kg	101392
20 L	canister	20.70 kg	101393

Lubricant Pump

For Glit®, Glit® F200 and Glit® Blue

pump incl. adapter	weight	art.-no.
fitted for canister 20 L & 30 L	1.05 kg	107080



Cable Guide Heads

for direct insertion of cables into short conduits

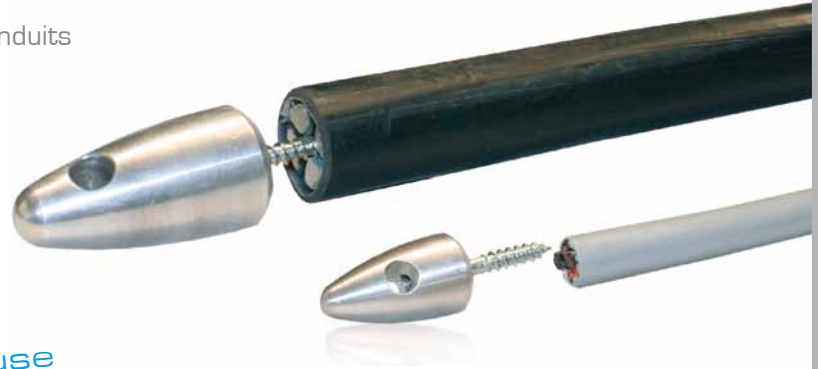

fast, simple & effective use

By **easy screwing** of the heads onto the cables those can be **pushed easily and quickly** into short conduits.

previous working steps:

- insertion of the pulling rod
- connection of cable and pulling rod
- pulling-in
- disconnection of cable and rod

working steps with cable guide head:

- screwing of the cable guide head onto the cable
- insertion of the cable

The **self-cutting thread** of the guiding heads is **tight enough**, even when the cable needs to be **pulled back**.

The **different types** of guiding heads can be used both **for standard cables** and wires in **domestic installation** and for **cables in underground** as well.



Cable Guide Heads

Cable guide head



Cable guide head
brass, self cutting thread

cable-Ø	weight	art.-no.
11/15 mm Set	50 g	101036
11 mm	15 g	101056
15 mm	25 g	101057

Cable guide head



Cable guide head
aluminium

cable-Ø	weight	art.-no.
up to 22 mm	30 g	103169
up to 30 mm	75 g	103170
30-50 mm	270 g	103171



Duct Pullers



Innerduct Pullers...
where there is no space for a cable grip

Innerduct Pullers - for high pressure and polyethylene pipes.

Innerduct Pullers are typically used in “**pipe-in-pipe**” installation, in horizontal borings, with cable plows and moles. Duct Pullers are **installed quickly** and require no special tooling.

Spread Innerduct Pullers or Duct Pullers with self-cutting, conically formed thread offer a **cheap chance** to renew pipes. They are available in a wide range of **different diameters**.

An additional reliability is provided because you can use the Duct Puller with screw-in tapered thread with or as well without integrated swivel.

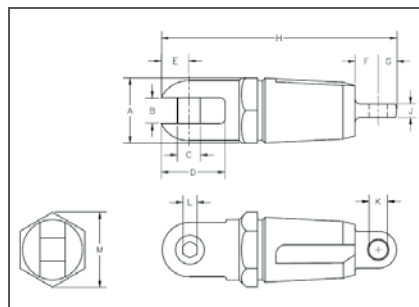



Duct Puller

Duct Puller



Duct Puller with swivel

With chrome plated surface with a screw-in tapered thread to grip the inside diameter of the duct. These Duct Pullers have a built in swivel head.

outside-Ø (mm)	duct-Ø (mm)	min. duct-Ø (mm)	max. duct-Ø (mm)	weight (kg)	art.-no.
31.8	32	23.9	29.2	0.30	107185
41.3	40	32.0	36.6	0.35	107186
44.4	50	37.6	42.2	0.70	107187
54.0	63	48.5	52.8	0.85	107188

Duct Puller



Duct Puller chrome plated

With chrome plated surface with screw-in tapered thread

outside-Ø (mm)	duct-Ø (mm)	min. duct-Ø (mm)	max. duct-Ø (mm)	weight (kg)	art.-no.
29	25	18.3	23.6	0.25	107190
35	32	25.4	30.0	0.36	107191
45	40	31.8	36.3	0.64	107192
51	50	38.1	42.7	0.91	107193
64	63	50.8	55.4	1.50	107194

Duct Puller



Duct Puller with clamping system

the most efficient way to allow the safe towing of polymer pipes into position

duct-Ø (mm)	min. duct-Ø (mm)	max. duct-Ø (mm)	weight (kg)	art.-no.
25	18	22	0.10	107325
32	24	29	0.15	107326
40	30	37	0.20	107327
50	38	47	0.40	107328
55	42	49	0.90	107329
63	48	58	1.70	107330
75	56	70	2.40	107331
90	66	84	4.10	107332
110	82	100	7.40	107333
125	96	115	8.60	107334
140	105	130	8.80	107335
160	124	148	10.00	107336
180	126	166	15.00	107337
200	152	185	18.00	107338
225	163	205	25.00	107339
250	187	225	28.00	107340
280	221	259	38.00	107341
315	238	290	53.00	107342
355	270	325	60.00	107343